



## 2GIG® GC3 Security & Automation System

# User's Guide

10004670 B



**WARNING: OWNER'S INSTRUCTION NOTICE**  
Not to be removed by anyone except occupant

 **NORTEK**<sup>™</sup>  
SECURITY & CONTROL

The 2GIG, GC3, GoControl, and Linear logos are registered trademarks of Nortek Security & Control LLC in the United States and/or other countries. Other Nortek Security & Control trademarks may also appear in these materials. Other names or brands may be claimed as the property of others. For more information, contact your 2GIG alarm dealer for pricing or visit [www.nortek.com](http://www.nortek.com), [www.nortekcontrol.com](http://www.nortekcontrol.com), or [www.2gig.com](http://www.2gig.com).

This document utilizes the Cue gestural icon system by P.J. Onori, which is available under a Creative Commons Attribution-ShareAlike 3.0 United States (CC-BY-SA-3.0) license.

Information in this document is subject to change without notice. The availability of particular products, services, and features may vary by region. Please check with your local dealer for further details and availability of language options.

No part of this publication may be reproduced, stored in a retrieval system, or transmitted in any form or any means electronic or mechanical, including photocopying and recording for any purpose other than the purchaser's personal use without the written permission of Nortek Security & Control.

Nortek Security & Control  
5919 Sea Otter Place, Suite 100  
Carlsbad, CA 92010  
USA  
800-421-1587

## Contents

<b>Introduction</b>	<b>4</b>
About this Guide	4
Introduction to Smart Areas™	4
Document Conventions	5
Technical Support	6
<b>System Overview</b>	<b>6</b>
System Features and Capabilities	6
Additional Accessories	8
Setup and Installation	8
Operational Concepts	8
Features to Limit False Alarms	10
Limitations of Alarm Products	12
<b>Touchscreen Basics</b>	<b>13</b>
Waking the Touchscreen	13
To wake the touchscreen:	13
About the Home Screen	13
System Status Messages	14
System Icons	14
Using the Inbox	15
Using Bookmarks	17
Using the System Menus	18
Viewing the Weather Forecast	18
Responding to Trouble Alerts	19
<b>Burglary Protection</b>	<b>20</b>
Overview	20
Sample Burglary Alarm Plan	21
Arm the System	22
Force Bypassing	23
Use the Quick Exit Button	25
In the Event of an Exit Error	25
To Disarm the System	25
Transmit a User Duress Report	26
In the Event of a Burglary Alarm	27
<b>Fire and Carbon Monoxide Protection</b>	<b>30</b>
Overview	30
Important Concepts	30

National Fire Alarm and Signaling Code . . . . .	30
Recommended Smoke Alarm Placement . . . . .	30
Emergency Action Plan . . . . .	31
In the Event of a Fire Alarm . . . . .	31
Silence a False Fire Alarm . . . . .	31
<b>Emergency Features . . . . .</b>	<b>32</b>
24-Hour Alarm Buttons . . . . .	32
In the Event of a Carbon Monoxide Alarm . . . . .	32
Clear the Alarm History . . . . .	32
Activate a Manual Panic, Fire, or Emergency Alarm . . . . .	33
<b>Remote Control . . . . .</b>	<b>34</b>
Remote Control Devices . . . . .	34
Operate the System with a Key Fob . . . . .	34
<b>Smart Home Controls . . . . .</b>	<b>34</b>
About the Smart Home Controls Menu . . . . .	34
Navigate to the Smart Home Controls Menu . . . . .	34
Lights . . . . .	35
Locks . . . . .	35
Thermostats . . . . .	35
Garage Doors . . . . .	36
Scenes . . . . .	36
Add a New Room . . . . .	39
Smart Areas . . . . .	41
<b>System Info and Usage . . . . .</b>	<b>43</b>
History . . . . .	43
System Info . . . . .	44
Dealer Info . . . . .	45
<b>System Settings . . . . .</b>	<b>46</b>
Users . . . . .	46
Sounds . . . . .	52
Bypass Sensors . . . . .	53
Smart Home Settings Menu . . . . .	55
Screen . . . . .	67
Language . . . . .	68
System Tests . . . . .	68
Firmware Update . . . . .	71
Broadband . . . . .	71
Attaching to a Wireless Network . . . . .	72
Selection Buttons . . . . .	73
Wired (Ethernet) . . . . .	74
Replace the GC3 Cellular Radio Module . . . . .	76
Chimes . . . . .	78
Smart Areas Settings . . . . .	79
<b>Limited Warranty . . . . .</b>	<b>81</b>
Waste Electrical and Electronic Equipment (WEEE) Statement . . . . .	81
<b>WARNINGS . . . . .</b>	<b>81</b>
Limitations of Alarm Products . . . . .	81
Risk of Noise Induced Hearing Loss . . . . .	81

---

## Introduction

Before you get started, review this information.

### About this Guide

This guide is designed for end users of the GC3 Security & Automation System. It provides general system information, safety precautions, and step-by-step instructions for operating the system. It is intended for use only by GC3 Security & Automation System owners whose system has been professional installed in a residential or commercial setting by an authorized 2GIG alarm dealer.

For a list of 2GIG alarm dealers and distributors in your area, visit:

<http://www.nortekcontrol.com> or <http://www.2gig.com>.

### Introduction to Smart Areas™

Smart Areas is 2GIG's new partitioning solution. Partitioning is the process of dividing security sections of a home or building into smaller areas so that users can arm some sections of the house while leaving other areas disarmed. This provides home and building owners both security and convenience, as it allows them to walk through their structure without concern of tripping alarms for areas they'd like to keep secure and armed. Some examples of partitioning use cases include:

- » Arming a section of a room that contains a safe that contains gun collections or valuables. These areas may not be accessed as frequently as the other areas in the room.
- » Having a portion of the home designated for use by others, such as guests or property rentals. Partitioning enables the homeowner to arm some sections of the house they'd like to be 'off limits' to other people.
- » Disarming the garage while the homeowner is at work to allow a package to be delivered and stored safely on the premises.
- » Secure swimming pool or spa area to help reduce the risk of drowning accidents. In California, it is now required that newly-built pools and spas include at least one safety measure, including an alarm.

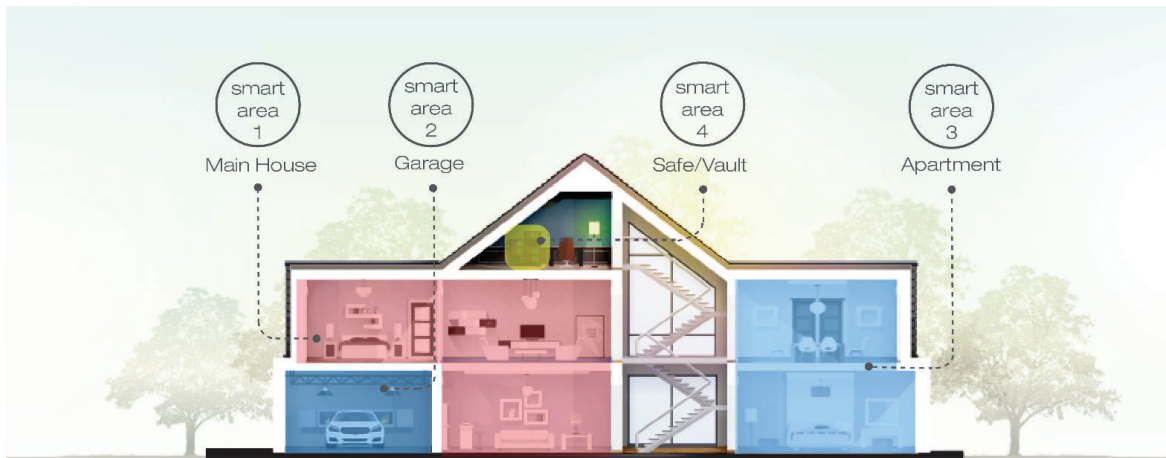

Smart Areas was designed for ease of setup and everyday use. For installation, the process for adding device enrollments has been simplified. All smart area parameters are displayed on the screen for quick scanning. This reduces time for the installer, who with legacy partitioning systems would have to memorize the codes and workflow, in addition to working through each parameter in a list to verify them. With the addition of Smart Areas, the GC3 becomes a self-contained partitioning panel, complete with user interface, controller, wireless transceiver, and communicator (cell radio and/or W-Fi) all in one package. This reduces complexity for the installer. All of the equipment is self-contained; there are no modules that require additional set up procedures.

For the end user, Smart Areas is a one-touch solution that provides Global System Access. They can now access any partition/Smart Area with appropriate authorization. 'Arm/Disarm' and 'Emergency/Panic' functions can be accessed quickly. No matter where in the menu a user finds themselves, all they need to do is press the 'Home' button and they immediately return to the 'Arm/Disarm' screen. Past partitioning examples required users to swipe from screen to screen. This added time, complexity and confusion for the user. The simplified user interface will reduce confusion and frustration for those who may not interact with their security system every day. With the common tasks upfront, it's easy to select without having to memorize.

## Document Conventions

This section describes the document conventions used in this guide.







## Safety Precautions and Notations

It is imperative that you observe all of the safety precautions documented in this guide. For your safety and the safety of others, the following table details how this guide calls special attention to information intended to safeguard life, health, and property.

<b>DANGER!!!</b> This notation is used to indicate hazardous situations which, if not avoided, will result in serious injury or death.	<b>WARNING!!</b> This notation is used to indicate potentially hazardous situations which, if not avoided, could result in serious injury or death.
<b>CAUTION!</b> This notation is used to indicate a potentially hazardous situation which, if not avoided, could result in minor or moderate injury.	<b>IMPORTANT:</b> This notation is used to indicate a situation which, if not avoided, could result in property damage, equipment damage, or data loss.
<b>NOTE:</b> This notation is used to call attention to notable information that should be followed when installing, servicing, or using this product.	<b>TIP:</b> This notation is used to call attention to helpful hints related to using the product.

## Touchscreen Navigation

This table describes the action words used to inform users of methods for touchscreen navigation.

Glyph	Action Word	Glyph	Action Word
	Tap (or single tap)		Swipe left
	Touch and hold		Swipe right
	Swipe down		Swipe up

## Typographic Conventions

The following typographic conventions are used to call attention to specific words and phrases:

- » **Bold** Highlights key information in list bullets and draws attention to words, phrases, and text encountered on the touchscreen's user interface. For example, "open the **System Settings** menu" or "swipe up and then tap the **System Info** button."
- » **Monospace** Denotes words, phrases, and text that must be manually entered by a user through the touchscreen's keypad. For example, enter the user code **1234** to access the **System Settings** menu.
- » *Italics* Denotes the names of variable information and optional settings that can be selected or entered using the touchscreen. It is also used to refer readers to other Nortek Security & Control or 2GIG product documents that you can read for more information.
- » **Dagger (†)** Indicates that a specific setting or value is a factory default setting or value. The setting or value on your particular system may be different.

---

## Technical Support

Should you require support services for this system, contact 2GIG Technical Support at Nortek Security & Control. For support in the USA and Canada, contact 2GIG Technical Support at Nortek Security & Control:

- » Telephone: 855-2GIG-TECH
- » Email: 2gigtechsupport@nortek.com Dealer Site: dealer.2gig.com
- » Websites: www.nortekcontrol.com and www.2gig.com

For support outside of the USA or Canada, contact your regional 2GIG distributor. For a list of distributors in your region, visit the websites above.

## System Overview

### System Features and Capabilities

If you're familiar with other 2GIG Control Panels, you'll notice the new GC3 Panel from Nortek Security & Control offers the very best components of the GC2 Panel and has been transformed by a major visual upgrade— offering a larger touchscreen and an intuitive user interface featuring convenient, gesture-based navigation.

*GC3 Control Panel - Front View*



## Features

The system includes:

- » **Touchscreen Display:** A large, full-color, 7-in (17.8 cm) diagonal touchscreen with an intuitive, gesture-based user interface.
- » **Piezo Sounder and Internal Speaker:** An 85 dB Piezo Sounder sounds external alarms. An internal speaker to delivers voice annunciations, chimes, other system notifications.

**CAUTION!** Long or repeated exposure to sounds at or above 85 dB can lead to Noise-Induced Hearing Loss (NIHL).

- » **Alarm Button/LED Indicator:** Tap this button to show Panic, Fire, and Emergency buttons. For more information, see the GC3 Security & Automation System Fingertip Guide.
- » **Home Button/LED Indicator:** A button to wake the touchscreen and give users the ability to return to the touchscreen's Home screen. For more information, see the GC3 Security & Automation System Fingertip Guide.

- 
- » **Removable Faceplate:** A removable faceplate concealing a door lock for the Cellular Radio Module bay.
  - » **Microphone and Speaker:** A built-in microphone and speaker provide clear 2-Way Voice communication during alarm events between users at the GC3 Panel and operators at the Central Station.
  - » **Cellular Radio Module with Internal Antenna:** A snap-in Cellular Radio Module with an internal antenna that fits neatly in the side panel.
  - » **24-Hour Backup Battery:** A 24-hour backup battery to support the GC3 Panel during temporary AC power failures and outages.
  - » **USB Port:** A convenient USB port at the top of the GC3 Panel that can be used with a USB thumb drive (not supplied) to update the system's firmware. See "Update the GC3 Panel Firmware."
  - » **WiFi:** The built-in WiFi module allows the system to be connected to a WiFi network for dual path communication, OTA updates, and connection with secondary keypads.
  - » **Ethernet:** (optional) An Ethernet module can be added to the system to allow for a hardwired connection to a local network for dual path communication, OTA updates, and connection with secondary keypads.
  - » **Access Point:** The built-in Access Point allows for a direct connection with secondary keypads via WiFi without the need to connect to a local network.

## Capabilities

The system includes these capabilities:

- » **Smart Areas:** (Optional) The system supports a Maximum of 4 Smart Areas. Zones may be assigned across Smart Areas to allow for independent control.
- » **Security Codes:** The system supports a maximum of 100 unique, programmable, security codes for accessing system functions. You are provided with one (1) Master User Code, one (1) Duress Code, and one (1) Installer Code (reserved for use by 2GIG alarm dealers and installers), and the ability to create 98 additional user codes for accessing the system.
- » **Z-Wave® and Z-Wave Plus™ Compatibility:** Installers (and end users, if configured on the system) can add up to 232 smart home devices to communicate with the GC3 Panel using the Z- Wave and Z-Wave Plus wireless communication protocol. The GC3 Panel can be included and operated in any Z-Wave network with other Z-Wave certified devices from other manufacturers and/or other applications. All non-battery operated nodes within the network will act as repeaters regardless of vendor to increase reliability of the network. This device is a security enabled Z-Wave Plus product that is able to use encrypted Z-Wave Plus messages to communicate to other security enabled Z-Wave Plus products.
- » **2-Way Voice:** (Optional) Operators at the Central Station can communicate directly with end users through the GC3 Panel . Operators can also silently listen-in after receiving a user duress report.
- » **Date, Time, and Weather Forecasts<sup>1</sup>:** Users can view the current date, time, and weather forecast in an easy-to-read format.
- » **System Vocabulary/Voice Descriptors:** A list of vocabulary words integrates with the on-screen user interface and audio announcements. This lets installers customize the sensor names that display on the GC3 Panel , as well as for the audible system announcements. For example, when someone opens the front door, the system can be set up to announce "front door."

<sup>1</sup> Date, Time and Weather Forecasts are supported by most Remote Service Providers in most regions. Consult your provider to determine if this feature is enabled.

---

## Additional Accessories

The installer typically sets up the system to communicate with a variety of wired and/or wireless sensors. Some sensors are visible on the wall or ceiling. For example, Wireless Smoke/Heat/Freeze Alarms and Wireless Carbon Monoxide Detectors. Others may be hidden in door jambs. For example, Recessed Door/Window Contacts. Sensors might also be installed in additional locations. For example, a Glass Break Detector and a Passive Infrared Motion Detector.

**NOTE:** A variety of 2GIG and GoControl branded devices are compatible with the GC3 Security & Automation System. Sensors manufactured by other companies may also be compatible with the system. For information, visit [dealer.2gig.com](http://dealer.2gig.com)

**IMPORTANT:** This notation is used to indicate a situation which, if not avoided, could result in property damage, equipment damage, or data loss.

**IMPORTANT:** To ensure that the system's sensors are operating properly, it is important for 2GIG alarm dealers and system owners to ensure sensor batteries and wireless signals are tested at least once a year.

Depending on the specific installation, systems may also be installed with one or more of the following 2GIG accessories:

### Kits & Keypads

- » 2GIG Control Panel Desktop Kit
- » 2GIG SP1 Keypad
- » 2GIG SP2 Keypad
- » 2GIG PAD1

- » 2GIG Smoke/Heat Detector
- » 2GIG Panic Button Remote
- » 2GIG Carbon Monoxide Sensor
- » 2GIG Takeover Module
- » 2GIG Doorbell
- » Universal Garage Door Receiver

### Radios & Antennas

- » 2GIG Cellular Radio Module
- » 2GIG External Attic Mount Antenna

- » 2GIG Tilt Sensor
- » 2GIG Bypass Sensor
- » 2GIG Flood Sensor
- » 2GIG Repeater

### Sensors & Peripherals

- » 2GIG Thin Door/Window Surface Contact
- » 2GIG Recessed Door/Window Contact
- » 2GIG Passive Infrared (PIR) Motion Detector
- » 2GIG Glass Break Detector
- » 2GIG Smoke/Heat/Freeze Alarm

## Z-Wave Smart Home Controls

Consult your 2GIG alarm dealer for information about installing a wide variety of compatible Z-Wave smart home controls including:

- » Lights
- » Locks
- » Thermostats
- » GDZ

## Setup and Installation

The GC3 Security & Automation System must be installed by a qualified technician who is either employed by, or under contract with, a 2GIG alarm dealer. The alarm must always be installed in accordance with your country's national electrical installation regulations and/or all applicable codes in the local jurisdiction.

## Operational Concepts

Understanding these concepts will help you operate the system:

### 24-Hour Alarm Buttons

An installer can configure the GC3 Panel to show or hide three 24-hour alarm buttons on the touchscreen: **Panic**, **Fire**, and **Emergency**. When the buttons are enabled and visible, users can manually trigger an alarm from the GC3 Panel. Alarms can also be activated from a wireless keypad (if installed), from wireless sensors, or from portable devices (for example, a Panic Button Remote). See "Emergency Features."



---

## Alarm

When the system detects an alarm condition, it immediately sounds an audible alarm that continues for a preset amount of time. If external alarm sounders or Z-Wave sirens have been installed, those devices also sound an audible alarm. During an alarm (and also after a user cancels or clears the alarm), the **Alarm History** reveals a chronological list of the alarms that have occurred by zone. The next time you arm the system, the system automatically clears the history. You can also manually clear the history.

See “Clear the Alarm History.”

## Burglary Protection

Burglary protection is provided by a combination of perimeter and interior sensors installed on doors, windows, and other areas of a dwelling. See “Burglary Protection.”

## Security Codes

The system supports a maximum of 100 unique security codes. There are four types of security codes supported by the system: (1) Master User, (2) User, (3) Duress, and (4) the Installer Code, which is reserved for use by 2GIG alarm dealers and installer. See “Users.”

## Fire and Gas Protection

Fire and gas protection are provided by a combination of Wireless Carbon Monoxide Detectors and Wireless Smoke/Heat/Freeze Alarms that protect your dwelling 24 hours-a-day. When an alarm condition is detected, the system sounds an alarm and transmits a report to the Central Station so operators can dispatch the appropriate emergency services. See “Fire & Carbon Monoxide Protection.”

## Sensor Types

When programming the sensor into the system, the installer sets the sensor type for each device. This determines how and when the system will react when a sensor detects an alarm condition. Fire protection sensors protect the dwelling 24-hours a day, whereas burglary protection sensors only protect the premises when the system is armed.

## Trouble Alerts

The system monitors itself for abnormal operating conditions and alerts you when trouble is detected. Examples of alert conditions include

AC power loss at the GC3 Panel, low battery conditions at a sensor, and more. See “Responding to Trouble Alerts.” The installer can configure the system to transmit a variety of trouble alerts to the Central Station.

## Wired and Wireless Sensors

Your system can be installed with wired sensors, wireless sensors, or a combination of both. Some sensors are visible on the wall or ceiling (for example, Wireless Smoke/Heat/Freeze Alarms and Wireless Carbon Monoxide Detectors), while others may be hidden in doorjambes (for example, Recessed Door Contacts). Sensors can also be mounted in different locations (for example, Glass Break Detectors and Passive Infrared Motion Detectors).

## Zones

The system’s wired and/or wireless sensors that have been programmed by the installer are also sometimes referred to as zones. Examples of zones that are typically set up for a home installation include *Front Door*, *Sliding Glass Door*, *Living Room Bay Window*, and so on.

## Features to Limit False Alarms

For compliance with *ANSI/SIA CP-01-2010: Control Panel Standard - Features for False Alarm Reduction*, the installer can set a variety of different options designed to limit occurrences of a False Alarm.

### *ANSI/SIA CP-01-2010 Features to Limit False Alarms*

<b>ANSI/SIA CP-01-2010</b>	<b>2GIG System Feature</b>	<b>User Guide</b>
4.2.2.1 Exit Time	Exit Delay	“Important Concepts” “Arm the System”
4.2.2.2 Progress Annuciation	Exit Delay Announcement	“Important Concepts” “Arm the System”
4.2.2.3 Exit Time Restart	Exit Delay Restart	“Important Concepts” “Arm the System”
4.2.2.4 Exit Error	Exit Error	“In the Event of an Exit Error”
4.2.2.5 Unvacated Premises	Auto Stay	“Arm the System (Away Mode)”
4.2.3.1 Entry Delay	Entry Delay	“Important Concepts” “To Disarm the System”
4.3.2.2 Progress Annuciation	Entry Delay Announcement	“Important Concepts” “To Disarm the System”
4.3.2.3 Disarm	Disarming Features	“Important Concepts” “To Disarm the System”
4.2.4.1 Control Buttons	Keyfob/Remote Arming Mode on System Not Ready	“Remote Control Devices”
4.2.4.2 Manual Alarms	Emergency Alarm Features	“Activate a Manual Panic, Fire, or Emergency Alarm”
4.2.4.3 System Acknowledgment	Alert Keyfob Disarming After Alarm, Keyfob Arm/Disarm Confirmation	“Arming the System Using a Keyfob” “Disarming the System Using a Keyfob”
4.2.4.4 Remote Arming	Key Fob Arming	“Arming the System Using a Keyfob”
4.3.4.5 Remote Disarming	Key Fob Arming	“Disarming the System Using a Keyfob”
4.2.5.1 Abort Window	Abort Window Dialer Delay	“In the Event of a Burglary Alarm”
4.2.5.1.1 Disarm	Abort Window Dialer Delay	“In the Event of a Burglary Alarm”
4.2.5.1.2 Abort	Abort Window Dialer Delay	“In the Event of a Burglary Alarm”
4.2.5.2 Alarm Transmission	Abort Window Dialer Delay	“In the Event of a Burglary Alarm”

ANSI/SIA CP-01-2010	2GIG System Feature	User Guide
4.2.5.3 Disarm	Disarm	"To Disarm the System"
4.2.5.4 Cancel Window	Alarm Cancel Time, Alarm Cancel Display	"In the Event of a Burglary Alarm." and "Silence a False Fire Alarm"
4.2.6.1 Use of Duress Feature	User Duress Report	"Transmit a User Duress Report"
4.2.6.2 Duress Code	Duress Code	"Types of User Codes" "Users"
4.2.7 Initiation of Manual Alarms	Panic, Fire, or Emergency Alarm	"Activate a Manual Panic, Fire, or Emergency Alarm"
4.3.1 Cross Zoning	Cross Sensor Zones, Cross Sensor Timeout	"Q26: Cross sensor zones (99-100)" in the <i>GC3 Installation &amp; Programming Guide</i> . "Q27: Cross sensor timeout, in seconds (10-120)" in the <i>GC3 Installation &amp; Programming Guide</i> .
4.3.2 Swinger Shutdown	Swinger Shutdown Count (1-6)	"Q25: Swinger shutdown count (1-6)" in the <i>GC3 Installation &amp; Programming Guide</i> .
4.3.3	Fire & Carbon Monoxide Protection	"Fire & Carbon Monoxide Protection"
4.6.3	Console Test Sensors Test	"System Tests"

## Use and Care of the System

To care for the system, observe the following:

- » **Humidity and Liquids** Do not expose the system to water, rain, extreme humidity, perspiration, or other liquids. The optimum humidity range for the system is 9-90% non-condensing.
- » **Extreme Heat or Cold** Do not expose the system to extreme heat or cold. The optimum operating temperature range is 32° to 120° F (0° to 49° C).
- » **Shock and Vibration** For optimum protection against shock and vibration, make sure that your installer has securely mounted the touchscreen flush against the wall or properly installed it in a compatible desktop kit.

**IMPORTANT:** To prevent touchscreen damage during cleaning, see "Screen."

---

## Limitations of Alarm Products

This security system cannot offer guaranteed protection against burglary, fire, or other emergencies. Any alarm, whether commercial or residential, is subject to compromise or failure to warn for a variety of reasons. For example:

- » Intruders may gain access through unprotected openings or have the technical sophistication to bypass an alarm sensor or disconnect an alarm warning device.
- » Intrusion detectors (sensors) do not work without power. Battery operated devices do not work without batteries, with dead batteries, or if the batteries are not put in properly. Devices powered solely by AC do not work if their AC power supply is cut off for any reason, however briefly.
- » Signals sent by wireless sensors may be blocked or reflected by metal before they reach the alarm Control Panel, even if the signal path has been recently checked during a weekly test.
- » Blockage can occur if a metal object has been moved into the sensor's signal path.
- » A user may not be able to reach a panic or emergency button quickly enough.
- » Telephone lines needed to transmit alarm signals from a premises to a Central Station may be out of service or temporarily out of service. Telephone lines are also subject to compromise by sophisticated intruders.
- » Even if the system responds to the emergency as intended, however, occupants may have insufficient time to protect themselves from the emergency situation. In the case of a monitored alarm system, authorities may not respond appropriately.
- » Alarm warning devices such as sirens, bells, or horns may not alert people or wake up sleepers if they are located on the other side of closed or partly open doors. If warning devices sound on a different level of the residence from the bedrooms, then they are less likely to waken or alert people inside the bedrooms. Even persons who are awake may not hear the warning if the alarm is muffled from a stereo, radio, air conditioner, or other appliance, or by passing traffic. Finally, alarm warning devices, however loud, may not warn hearing-impaired people or awaken deep sleepers.
- » While smoke detectors have played a key role in reducing residential fire deaths, they may not activate or provide early warning for a variety of reasons in as many as 35% of all fires, according to data published by the Federal Emergency Management Agency. Some of the reasons smoke detectors used in conjunction with this system may not work are where smoke cannot reach the detectors, such as in chimneys, in walls, or roofs, or on the other side of closed doors. Smoke detectors may have been improperly installed and positioned. Smoke detectors also may not sense a fire on another level of a residence or building. A second-floor detector, for example, may not sense a first floor or basement fire. Moreover, smoke detectors have sensing limitations. No smoke detector can sense every kind of fire every time. In general, detectors may not always warn about fires caused by carelessness and safety hazards like smoking in bed, violent explosions, escaping gas, improper storage of flammable materials, overloaded electrical circuits, children playing with matches, or arson. Depending upon the nature of the fire and/or the locations of the smoke detectors, the detector, even if it operates as anticipated, may not provide sufficient warning to allow occupants to escape in time to prevent injury or death.
- » This equipment, like other electrical devices, is subject to component failure. Even though this equipment is designed to last as long as ten years, the electronic components could fail at any time.

The most common cause of an alarm system not functioning when an intrusion or fire occurs is inadequate maintenance.

Although installing an alarm system may make homeowners eligible for lower insurance rates, an alarm system is not a substitute for insurance. Homeowners, property owners, and renters should continue to act prudently in protecting themselves and continue to insure their lives and property.

## Touchscreen Basics

### Waking the Touchscreen

During periods of inactivity, the touchscreen automatically times out and enters sleep mode. To place it into full-power mode, you must wake the touchscreen.

*Wake the Touchscreen*

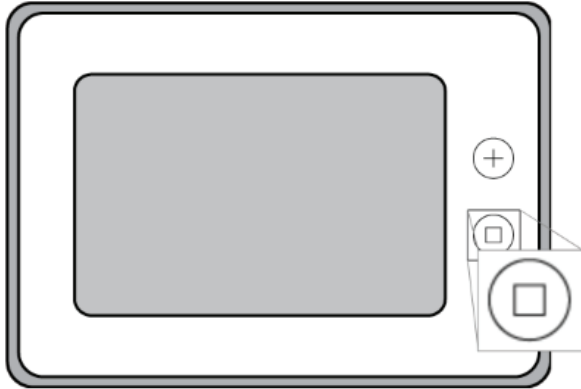

### To wake the touchscreen:

- » Tap any area on the touchscreen.
- OR
- » Press the Home button to the right of the touchscreen.

This reveals the Home screen. See “About the Home Screen” below.

**TIP :** The touchscreen goes into sleep mode after one (1) minute of inactivity. To change this setting to between 30 seconds and 10 minutes, tap **System Settings**, enter the Master User Code, tap **Screen**, and then change the **Screen Timeout** setting.

### About the Home Screen

When you first wake the system, it reveals the Home screen.

*Home Screen Features*

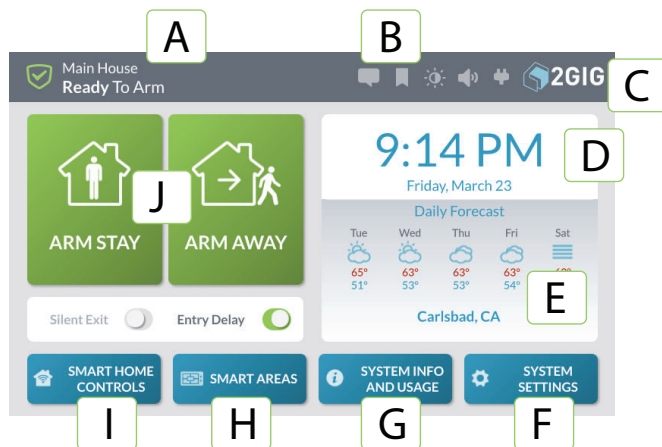

**NOTE:** Access to some features is restricted. To gain access to a restricted feature, you must know the four-digit Master User Code. See “Users.”

*Home Screen Features Table*

	This feature...	Does this ...	To learn more ...
<b>A</b>	System Status Messages	Reveals the current system state.	See “System Status Messages.”
<b>B</b>	System Icons	Provides access to messaging features, bookmarks, brightness/volume controls, and displays the current power source.	See “System Icons.”
<b>C</b>	System Logo	Tap the logo and then enter the Duress Code to transmit a User Duress signal to the Central Station.	See “System Logo.”
<b>D</b>	Date/Time	View the current date/time.	See “Date/Time.”
<b>E</b>	Weather Forecast	View the current weather forecast (when enabled for your system).	See “Viewing the Weather Forecast.”
<b>F</b>	System Settings	Gives anyone who knows the Master User Code access to a variety of general system settings.	See “System Settings.”
<b>G</b>	System Info and Usage	View general <b>System Information, History, and Dealer Info.</b>	See “System Info and Usage.”
<b>H</b>	Access Smart Areas Control	Arm/Disarm and acknowledge alarms and troubles for all areas.	See “About Smart Areas Control Menu.”
<b>I</b>	Smart Home Controls	Access your system’s smart home controls.	See “About the Smart Home Controls Menu.”
<b>J</b>	Security Features	Lets users arm/disarm the system.	See “Arm the System.”

## System Status Messages

At the top-left of the screen, different messages appear to reveal the current system state.

### System Status Messages



This table describes the different system status messages on the system.

This system status message ...	Indicates that ...
System <b>Ready</b> To Arm	Indicates all sensors are closed and the system is ready to be armed.
System <b>Not Ready</b> to Arm	One or more sensors are open.
System <b>Ready</b> To Arm (BYPASS)	The system is ready to arm and one or more sensors are on the Bypassed Sensors list. See "Force Bypassing."
System Arming (STAY)	The system is in the process of arming itself in Stay Mode.
System Arming (AWAY)	The system is in the process of arming itself in Away Mode.
System Armed	The system is armed and protecting the premises.
Restarting Security Process	The security system is restarting. Typically, this only appears after an installer modifies a System Configuration setting.

## System Icons

The status bar that appears on the top of the Home screen and on most system menus reveals a variety of icons providing system information and access to different functions.

### System Status Bar



### System Icons

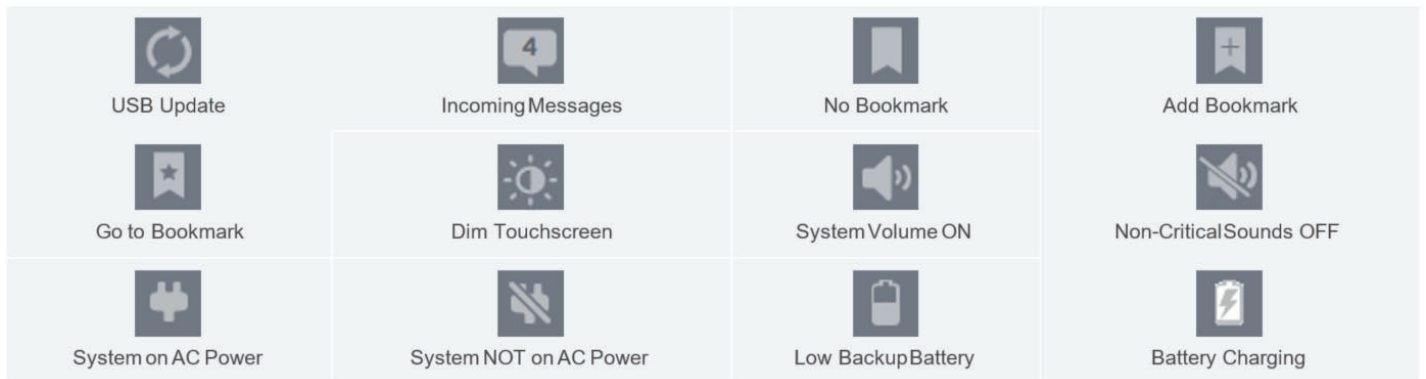

## Using the Inbox

There are three (3) types of messages that arrive in the Inbox: Alerts, Alarms, and Messages. When a new message arrives, the **Messages** system icon at the top of the screen blinks and shows the number of new, unread messages. When a new message arrives, the system emits three (3) beeps once every minute until the message is read.

*Messages System Icon*



## Reading Alert Messages

To read an alert message:

1. Tap the **Unread Messages** system icon.
2. In the drop-down menu, tap **Alerts**.

*Unread Messages > Alerts*

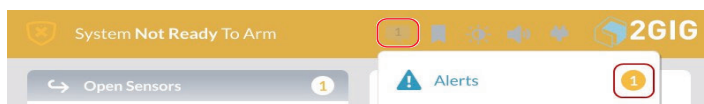

The system reveals the alert messages.

## Reading Alarm Messages

If the system goes into an alarm state, a message is sent to the Inbox. To read an alarm message:

1. Tap the **Unread Messages** system icon.
2. In the drop-down menu, tap **Alarms**.

*Unread Messages > Alarms*



The system reveals the alarm messages.

## Reading Incoming Messages

Your security provider has the ability to transmit messages about system upgrades, additional services, special regional weather alerts, and so on.

When transmitting messages to your system, your security provider can:

- » **Mark a Message as Public or Private:** A public message can be read by any user. A private message can only be opened by users who know the Master User Code.
- » **Classify a Message as High or Low Priority:** Message classified by the sender as High priority messages appear in YELLOW. Low priority messages appear in GRAY.
- » **Specify When or If Messages Expire:** There is no enforced limit on the number of messages that you can keep in the Inbox. However, messages that have been set to expire will be automatically removed from the Inbox at the time and date specified by the sender.

To read messages sent by your security provider:

1. Tap the **Unread Messages** system icon.
2. In the drop-down menu, tap **Messages**.

*Messages > Reading Messages*

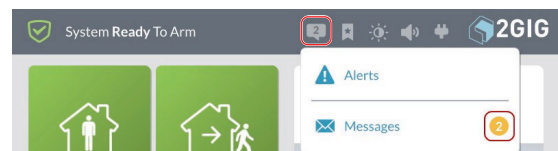

This reveals the Messages screen.

3. Before opening the message, it helps to understand the following:
  - » If a message was marked by the sender as Low priority, it appears in GRAY.
  - » If a message was marked by the sender as High priority, it appears in YELLOW.
  - » If a message was marked as private, a lock icon appears next to the message.

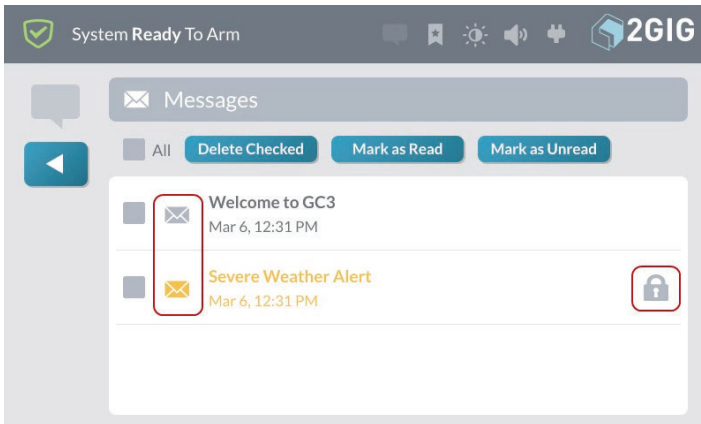

4. Tap the desired message to open it.
5. If the message was marked as private, enter your system's four-digit Master User Code.

*Enter Your Code to Read the Message*

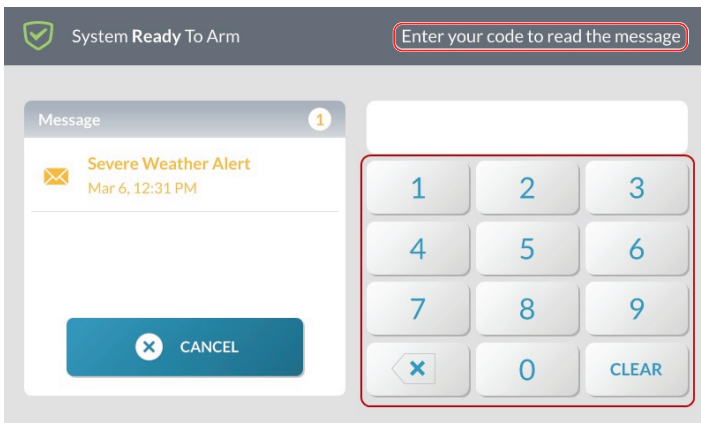

6. When the message appears, read the text.

*Reading a Message*

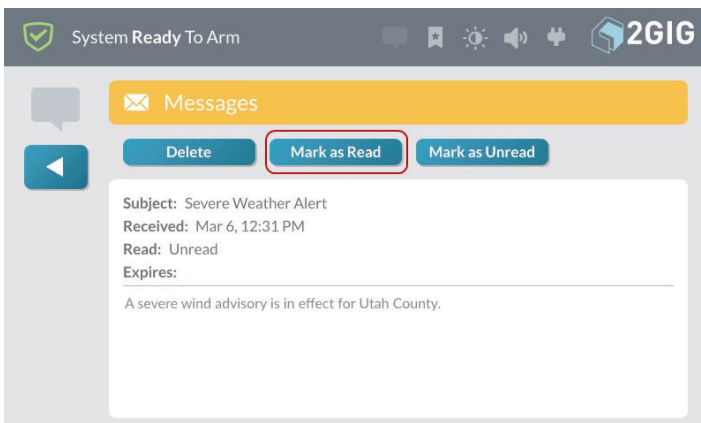

### Marking a Message as Read

After reading a message, the system automatically marks the message as read. You can also manually mark the message as read.

To mark a message as read:

1. Open the desired message.
2. After reading the text, tap **Mark as Read**.

*Messages > Mark as Read Button*

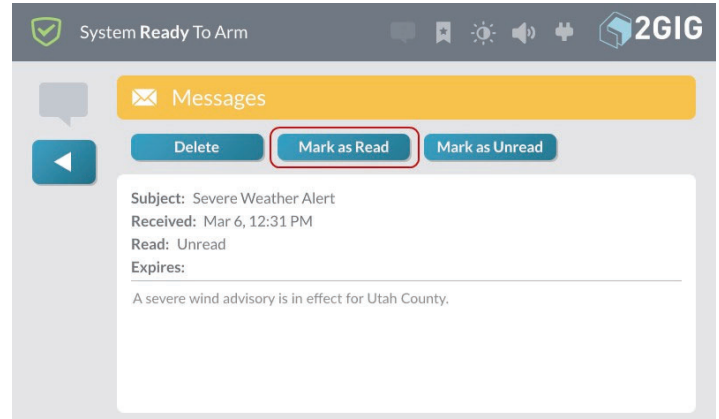

The system marks the message as read.

### Marking a Message as Unread

If you want to keep a message in the unread status after reading it, you can mark the message as unread.

To mark a message as unread:

1. Open the desired message.
2. After reading the text, tap **Mark as Unread**.

*Messages > Mark as Unread Button*

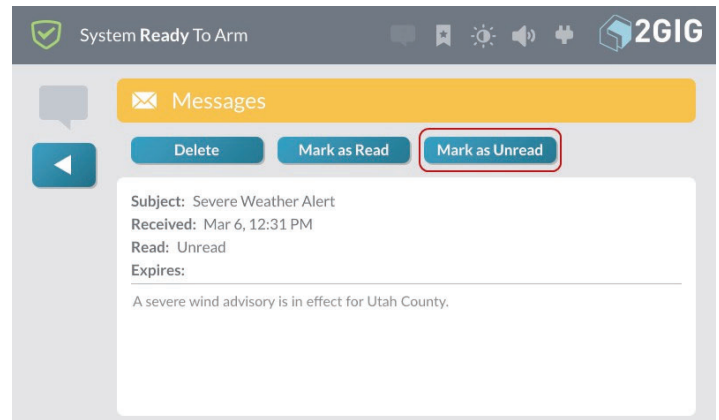

The system marks the message as unread.

### Deleting a Message

If you want to permanently remove a message from the Inbox, you can delete it.

To delete a message:

1. Open the desired message.
2. After reading the text, tap **Delete**.



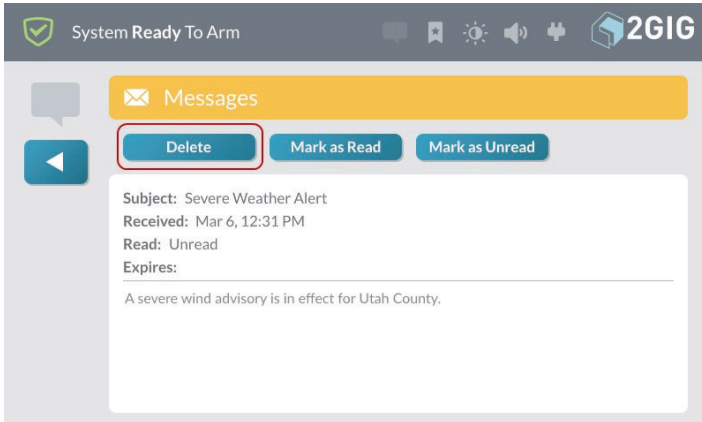

The system deletes the message from the Inbox.

### Using Bookmarks

If you frequently navigate to a particular screen, you can bookmark it which will make it the default home screen. The system lets you bookmark one (1) screen. This feature is typically used to bookmark a room.

### Bookmarking a Screen

To bookmark a screen:

1. Navigate to the desired screen.  
For example, tap **Smart Home Controls**. Then tap **Rooms** and then tap on a Room you have created.
2. Tap the **Add Bookmark** system icon.

Add Bookmark System Icon

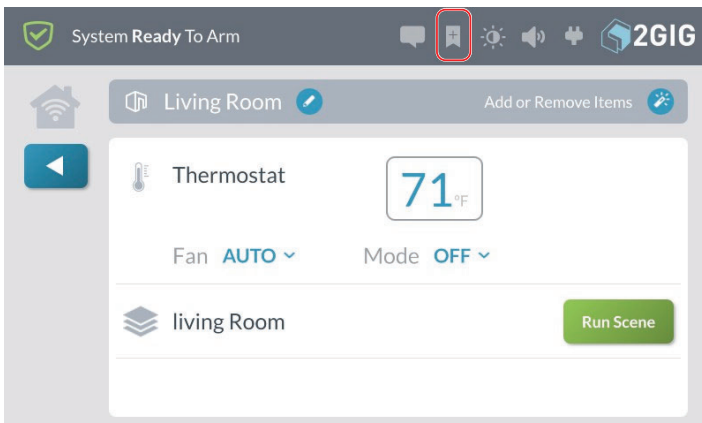

3. At the **Bookmark this screen?** message, tap **OK**.

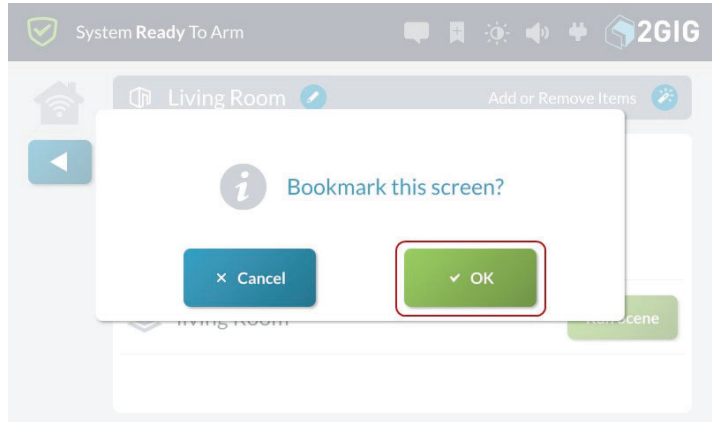

The system bookmarks the screen and a star appears on the bookmark icon. See "Opening a Bookmarked Screen" below.

The bookmarked screen now becomes the default home screen for the system. After 30 seconds of inactivity the panel will automatically display the bookmarked screen.

### Opening a Bookmarked Screen

If you have bookmarked a frequently used screen, a star appears on the system icon.

To go to the bookmarked screen:

4. Tap the **Open Bookmark** system icon.

Open Bookmark Icon

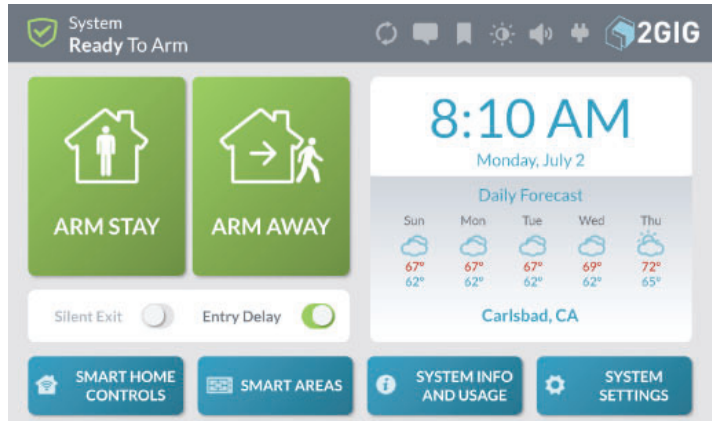

The system opens the bookmarked screen.

### Clearing a Bookmark

To clear a bookmark from a screen:

5. Navigate to the **Home** screen.
6. Press and hold the bookmark icon until a **Clear Bookmark?** message appears.

Tap **OK** to clear the bookmark.

## System Logo

In the top right corner of the Home screen, the system logo appears.

### System Logo

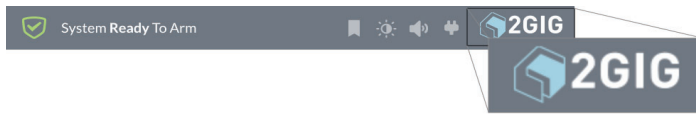

The system logo serves two functions:

- » **Duress Code:** Users can tap the logo at any time to enter the Duress Code. See “Transmit a User Duress Report.”
- » **Installer Toolbox:** 2GIG alarm dealers and installers can tap the logo and then enter the Installer Code to access the **Installer Toolbox** menu. See the *GC3 Installation & Programming Guide*.

**NOTE:** The logo may be changed to the security dealer’s logo.

## Viewing the Weather Forecast

If your Remote Service Provider provides weather forecasts and you have added this option as part of your service agreement, you can view five-day weather forecasts on the Home screen of the touchscreen display.

### Five-Day Weather Forecast

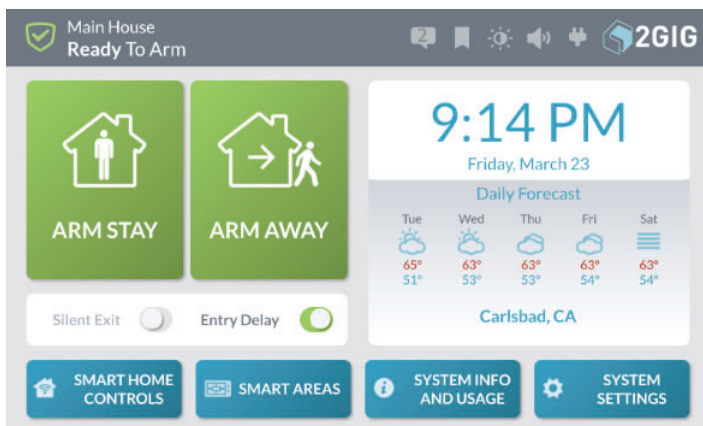

## Using the System Menus

Across the bottom of the Home screen, users can tap a button to access other menus. These menus include **Smart Home Controls**, **System Info and Usage**, and **System Settings**.

### System Menus



## Smart Home Controls

Tap the **Smart Home Controls** button on the Home screen to reveal the **Smart Home Controls** menu. These options give users the ability to operate any smart home devices (if installed) directly from the GC3 Panel. To learn about options in this menu, see “About the Smart Home Controls Menu.”

### Smart Home Controls Menu

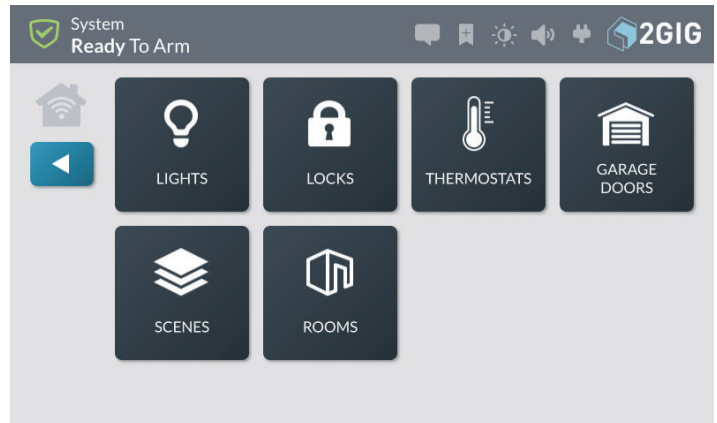

If the Smart Home Controls menu is not configured on your system, the following notification message appears when you tap the Smart Home Controls button. Tap OK to dismiss the message.

**NOTE:** Consult your security provider for information about enabling the Smart Home Controls feature on your system.

### Feature Not Currently Activated Message

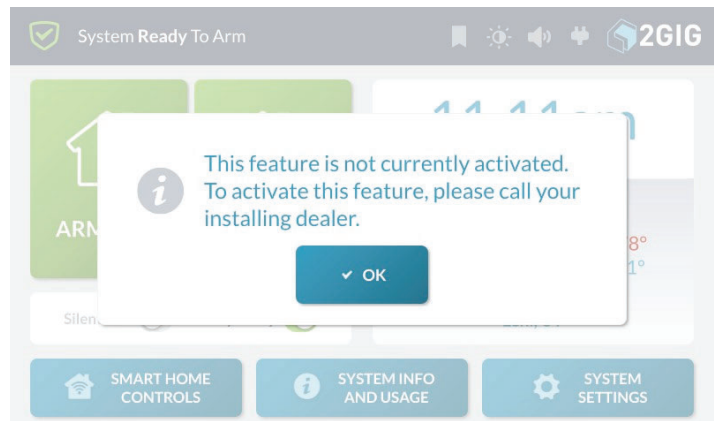

## Smart Areas

Tap the **System Smart Areas** button on the Home screen to reveal the **Smart Areas control screen**. This screen provides users with status and control of the Smart Areas to which they are assigned. To learn about the options in this menu, see “Smart Areas Info.”

*Smart Areas Control Screen*

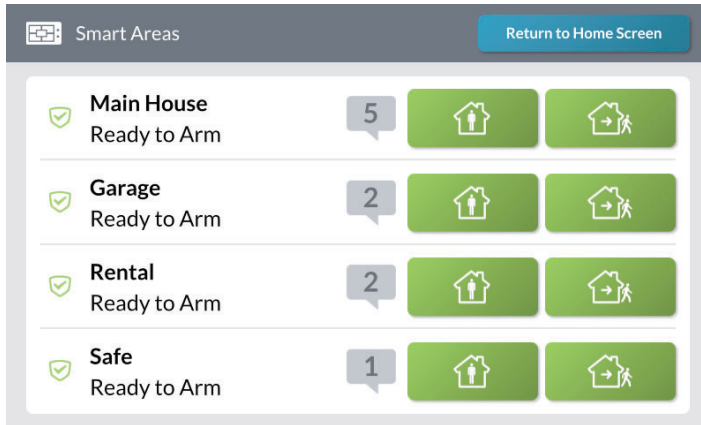

## System Info and Usage

Tap the **System Info and Usage** button on the Home screen to reveal the **System Info and Usage** menu. This menu provides users with access to system history, system information, and contact information for your 2GIG alarm dealer. To learn about the options in this menu, see “System Info and Usage.”

*System Info and Usage Menu*

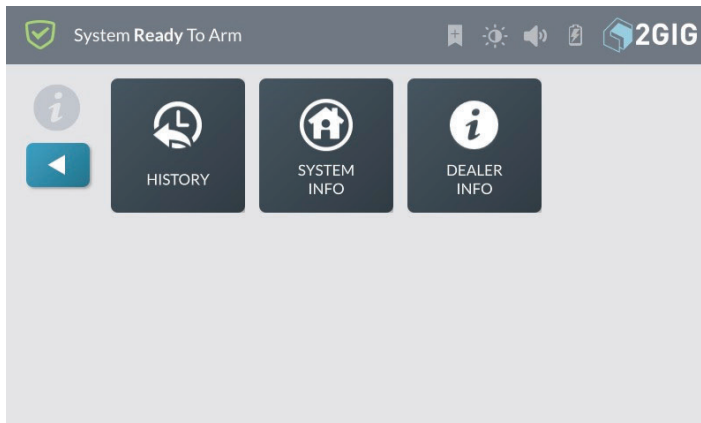

## System Settings

Tap the **System Settings** button on the Home screen to reveal the **System Settings** menu. This menu gives users access to general settings for the GC3 Security & Automation System. To learn about the options in this menu, “System Settings.”

**NOTE:** To use this feature, you must know the four-digit Master User Code.

## System Settings Menu

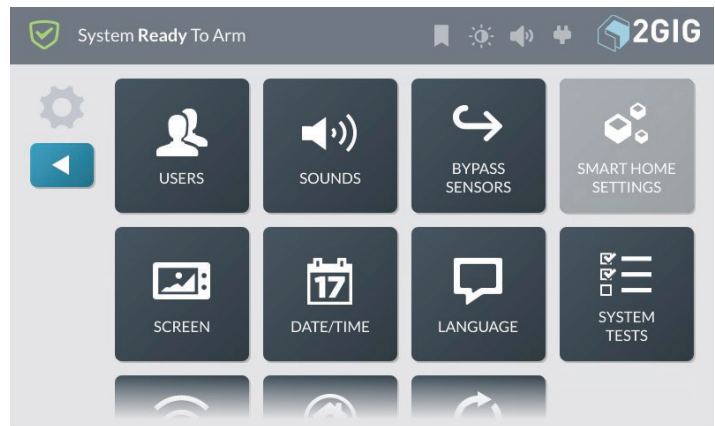

## Responding to Trouble Alerts

To ensure that all system components are operating under optimal conditions, the system continually polls all of the wired and wireless sensors paired with the system. It also continuously checks the GC3 Panel to ensure that it is operating properly. If a trouble condition is detected, the system alerts you of the issue.

## Monitoring the System for Trouble Conditions

The system monitors the GC3 Panel and its sensors so it can notify you when the following trouble conditions occur:

- » AC power loss to the panel
- » Cell radio connection interruption Sensor low battery
- » Panel backup battery low Sensor tamper
- » Panel tamper
- » Sensor supervision (if enabled)

## When a Trouble Condition Occurs

When a trouble condition occurs, the system alerts you so that either you or your 2GIG alarm dealer can promptly address the issue and return the system to proper working order:

- » An alert notification is sent to the system's Inbox and the Messages icon flashes.
- » The system sounds six (6) alert tones every minute, until the alert is acknowledged.

**NOTE:** Consult your installer to determine if the *Trouble Doesn't Sound at Night* feature is enabled on the system. When enabled, the system silences only the alert tones only during the hours of 10 p.m. to 9 a.m. It will not stop the trouble alert notification from displaying on the touchscreen so they can be acknowledged, nor will it stop the trouble alert report from being sent to the Central Station.

**NOTE:** For compliance with *UL 985: Household Fire Warning System Units*, the six (6) trouble alert tones for Wireless Smoke/Heat/Freeze Alarms and Wireless Carbon Monoxide Detectors are required to sound at an interval of once every four (4) hours, until the condition causing the alert is resolved.

» A trouble report is sent to the Central Station.

**NOTE:** Consult your installer to determine if the Trouble Reports to CS feature is enabled. When enabled, the system transmits trouble reports about sensors to the Central Station.

## Burglary Protection

### Overview

During setup, the installer typically configures a variety of wireless and wired sensors to protect your dwelling from unwanted intrusion. Different types of sensors may be installed in your dwelling for burglary protection including door/window contacts, glassbreak detectors, image sensors, and motion detectors. These sensors are intended to protect both the perimeter and interior of the premises.

**NOTE:** This burglary alarm system is in compliance with the standards defined in UL 681: Installation and Classification of Burglar and Holdup Alarm Systems and *UL 827: Central- Station Alarm Services*.

### Important Concepts

To help you get the most out of the burglary protection part of the system, it is useful to understand the concepts detailed below.

### Perimeter and Interior Sensors

The system provides burglary protection using a combination of sensors that have been installed in and around your dwelling:

- » **Perimeter Sensors:** Sensors intended to place the system into an alarm state when an intruder enters a dwelling. Perimeter sensors (for example, Door/Window Contacts and Wireless Glass Break Detectors) are typically installed at possible entry points, such as front doors, sliding glass doors, back doors, side doors, garage doors, and picture windows.
- » **Interior Sensors:** Sensors intended to place the system into an alarm state by detecting forced entry of the premises by an intruder. Interior sensors are typically installed at possible movement points. For example, a motion detector might be installed to detect movement across a basement, down a hallway, or up a stairwell.

Once installed, the system continuously monitors all of its sensors. For an alarm to sound, burglary protection sensors must be armed (see “Arm the System”). The system is also programmed by the installer to notify you about different events. For example, when you open a perimeter door, it transmits a status message to the GC3 Panel. The panel then shows that the door is open and the system announces the door’s voice descriptor.

### Protection Zones

When programmed into the system by the installer, each sensor is intended to protect a particular zone. Typical examples of zones that may be protected by a sensor include, *Front Door, Back Door, Basement Window, Laundry Room*, and so on. During programming, the installer may also create a voice descriptor for each zone. The GC3 Panel uses the voice descriptor in two ways:

- » As a verbal announcement to notify occupants when a perimeter sensor is open, closed, or when an alarm is set off.
- » As the display name of the sensor’s zone on the touchscreen.

### Stay and Away Mode

Unlike fire protection sensors (which are always ON and protecting the dwelling), burglary protection sensors must be turned ON (see “Arm the System”) and OFF (see “To Disarm the System”). This system can be armed in one of two modes:

- » **Stay Mode:** Arms the system except interior sensors. Arm the system in this mode when individuals will be occupying the premises. This arms only the sensor-protected perimeter doors and windows, leaving interior motion sensors or other interior doors unarmed. In a home setting, Stay Mode is frequently used during the evening hours when occupants do not intend to enter or exit the dwelling. This lets you move about without triggering the burglary alarm. Because all the interior burglary protection is OFF, an alarm would only be triggered if a sensor-protected perimeter door or window is opened.
- » **Away Mode:** Arms the system including interior sensors. Use this mode to arm the system when everyone will be leaving the premises. This mode arms all sensor-protected perimeter doors and windows, interior motion sensors, interior glass break sensors, and any other sensor-protected interior doors. Away Mode is frequently used during day time hours in residential installations and during non-business hours in commercial installations. Because all burglary protection features are ON, an alarm would be triggered when movement is detected, if any protected doors or windows are opened, or if glass breakage is detected (if glass break detectors have been installed).

## Open and Closed Sensors

Before you can arm your system, all protected doors, windows, and other protection zones must be closed or bypassed (see “Force Bypassing”). For example, if you leave a protected window open, the system considers it an open sensor. If a protected window is shut, the system considers it a closed sensor.

## Bypassed Sensors

When sensors are left open, the system cannot be armed unless that sensor is closed (see “Open and Closed Sensors” above) or added to the system’s Bypassed Sensors list. Bypassed Sensors are ones that you intentionally decide to leave unprotected. See “Force Bypassing.”

**NOTE:** Bypassed sensors offer no protection and cannot cause an alarm. Use bypass if you want to arm your system with one or more sensors open and intentionally unprotected.

## Sample Burglary Alarm Plan

Before the installation, your 2GIG alarm dealer will work with you to design, install, and configure a system intended to best protect your dwelling. This illustration is an example of a typical residential burglary alarm system offering both perimeter and interior protection:

*Sample Burglary Alarm Plan*

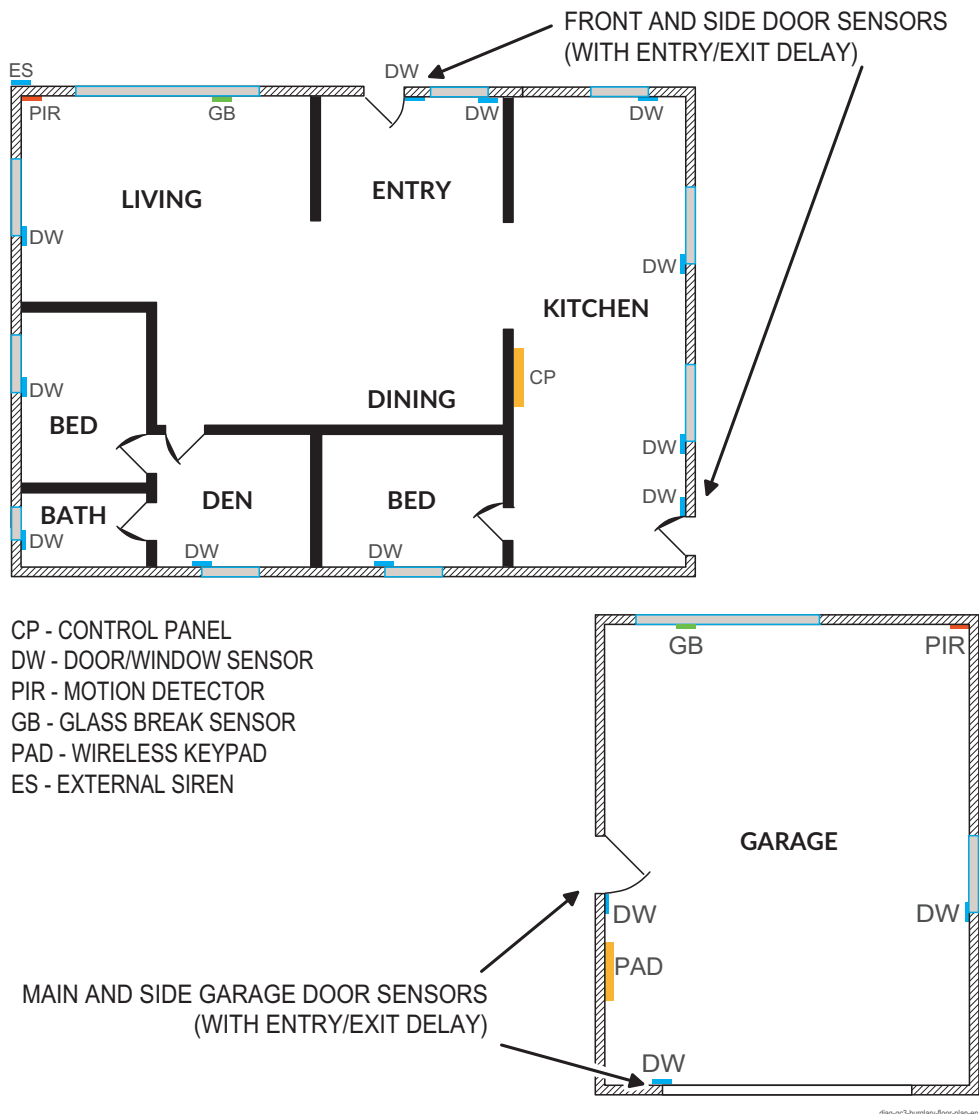

---

## Arm the System

You can arm the system only when the system status message indicates that it is in the *System Ready to Arm* or *System Ready to Arm (BYPASS)* state.

**IMPORTANT:** If any sensors are open (for example, a perimeter door or window is ajar) the system will be placed into the *System Not Ready to Arm* state and reveals the unprotected zone in **Sensors Not Ready** list on the touchscreen. Before you can arm the system, you must either close the open sensor(s) or bypass the open sensor(s). See “Force Bypassing.”

**TIP:** If you have purchased a key fob (or multiple fobs) to control the GC3 Security & Automation System, you can also arm the system using your key fob. See “Arming the System Using a Keyfob.”

### Arm the System (Stay Mode)

Stay Mode arms the system except interior sensors. Use this mode when occupants will be staying on the premises. In residential installations, Stay Mode is frequently used during the evening hours when occupants do not intend to enter or exit the dwelling. This lets you move about without triggering the burglary alarm. Because all the interior burglary protection is OFF, an alarm would only be triggered if a sensor-protected perimeter door or window is opened. To learn how to arm the system in Away Mode, see “Arm the System (Away Mode)” below.

**NOTE:** Consult your installer to determine if your system is configured with the *Quick Arming* feature. When enabled, the *Quick Arming* feature allows anyone to arm the system without entering a user code. When disabled, you must enter an active, four-digit user code to arm the system.

To arm the system in Stay Mode:

1. Ensure that all perimeter doors and windows are closed. The system status message should read *System Ready to Arm*. If the status messages reads *System Not Ready to Arm* and the **Sensors Not Ready** list appears, a protected door or window is open. You must first close that door/window or place it on the **Bypassed Sensors** list. See “Force Bypassing.”
2. At the Home screen, tap **Arm Stay**.
3. (Optional) At the Enter Your Code to Arm the System screen, enter an active, four-digit user code. If the Quick Arming feature is enabled, you will skip this step and not be prompted for a user code.

An *Exit Delay* countdown timer appears and the system announces “Arming Stay.” The countdown gives occupants time to enter or exit the premises through a protected door.

4. (Optional) To silence the countdown beeps and announcements, tap **Silence**. This turns the *Silent Exit* feature ON.

Once the countdown expires, occupants will not be able to enter or exit through protected doors and windows without triggering the burglary alarm.

### Arm the System (Away Mode)

Away Mode arms the system including interior sensors. Use this mode when occupants will be leaving the premises. When arming the system in Away Mode, the system arms all sensor-protected perimeter doors and windows, interior motion sensors, interior glass break sensors, and any other sensor-protected interior doors. In residential installations, Away Mode is frequently used during daytime hours. In commercial installations, it is most frequently used during non-business hours. Because all burglary protection features are ON, an alarm would be triggered when movement is detected, if any protected doors or windows are opened, or if the system detects breaking glass (if glass break detectors have been installed).

To learn how to arm the system in Stay Mode, see “Arm the System (Stay Mode)” above.

**NOTE:** Consult your installer to determine if your system is configured with the *Quick Arming* feature. When enabled, the *Quick Arming* feature allows anyone to arm the system without entering a user code. When disabled, you must enter an active, four-digit user code to arm the system.

To arm the system in Away Mode:

1. Ensure that all perimeter doors and windows are closed. The system status message should read *System Ready to Arm*. If the status messages reads *System Not Ready to Arm* and the **Sensors Not Ready** list appears, a protected door or window is open. You must first close that door/window or place it on the **Bypassed Sensors** list. See “Force Bypassing” on the facing in the next section.
2. At the Home screen, tap **Arm Away**.
3. (Optional) At the **Enter Your Code to Arm the System** screen, enter an active, four-digit user code. If the *Quick Arming* feature is enabled, you will skip this step and not be prompted for a user code.

An *Exit Delay* countdown timer appears and the system announces “Arming Stay.” The countdown gives occupants time to enter or exit the premises through a protected door.

**NOTE:** Consult your installer to determine how the *Exit Delay* feature is configured on your system (45- 120 seconds). For compliance with *ANSI/SIA CP-01-2010*, the *Exit Delay* feature is configured to 45 seconds by default.

**NOTE:** Consult your installer to determine if the *Exit Delay Restart* feature is enabled on your system. This feature restarts the *Exit Delay* countdown if an occupant enters or exits through a protected door or window before the countdown expires. For compliance with *ANSI/SIA CP-01-2010*, this feature must be enabled.

2. (Optional) If you want to silence the countdown beeps and announcements, tap *Silence*. This turns the *Silent Exit* feature ON and extends the *Exit Delay* countdown.

**NOTE:** Consult your installer to determine how the *Exit Delay* feature is configured on your system (45- 120 seconds). For compliance with *ANSI/SIA CP-01-2010*, the *Exit Delay* feature is configured to 45 seconds by default.

**NOTE:** If you want to cancel the arming action before the countdown expires, tap *Disarm*. Then enter an active, four-digit user code.

**NOTE:** Consult your installer to determine in the *Auto Stay* feature is enabled on your system. If you arm the system in *Away Mode* and no one exits through an *Exit Delay* door before the countdown expires, the system will automatically arm itself in *Stay Mode*.

During the *Exit Delay* countdown, the system emits a series of beeps that become faster during the last 10 seconds. Once the countdown expires, occupants will not be able to enter or exit through protected doors and windows without triggering the burglary alarm.

## Force Bypassing

When a protected door or window is open, the system places the sensor on its *Sensors Not Ready* list. In order to arm the system, you must either close the sensor or place it on the system’s *Bypassed Sensors* list. *Bypassed Sensors* are ones that you intentionally decide to leave unprotected. This method of bypassing a sensor is called *Force Bypassing*. To learn how to manually bypass a sensor, see “*Manually Bypassing a Sensor*.”

## Opening a Sensor When the System is Disarmed

When a protected door or window is opened while the system is disarmed, the GC3 Panel responds as follows:

- » The system status message on the touchscreen reads *System Not Ready to Arm*.
- » The **Sensors Not Ready** list and **Bypass All** button appears.
- » The name of the protected zone appears on the **Sensors Not Ready** list.
- » The number of open sensors appears in the top-right corner of the list.
- » The system uses the voice descriptor assigned to the sensor to announce that the protected zone is open.

*System Not Ready to Arm—Sensors Not Ready List*

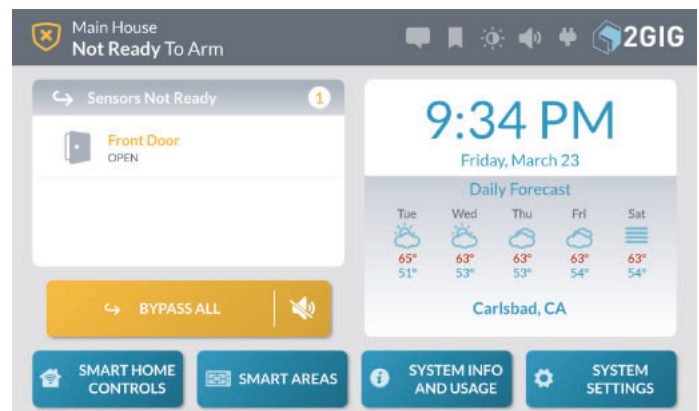

**WARNING!!** A bypassed burglary protection sensor does NOT provide security protection when the system is armed. See “*Bypass Sensors*.”

**NOTE:** Residential alarm systems do not permit you to bypass sensors installed in fire, carbon monoxide, or emergency zones.

**NOTE:** In order to bypass a sensor, you must know the Master User Code.

## Force Bypassing a Sensor

If you want to arm the system and ignore the open sensor, you must bypass the sensor. This is called “force” bypassing a sensor.

To force bypass the sensor:

1. Below the **Sensors Not Ready** list, tap **Bypass All**.

*Sensors Not Ready > Bypass All*

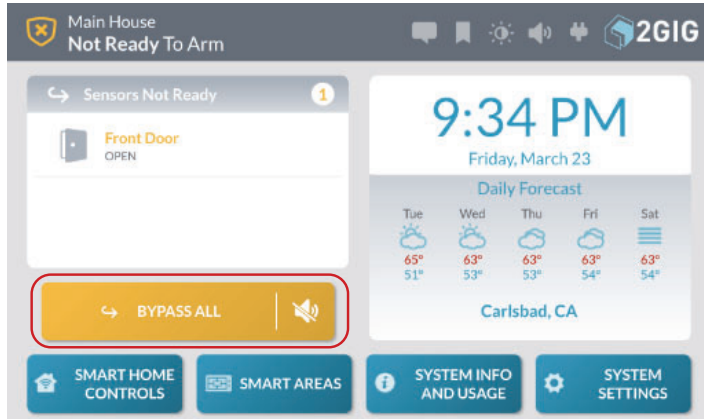

2. At the **Enter your code to bypass sensors** screen, enter an active, four-digit user code.

*Enter the Master Code to Bypass Sensors*

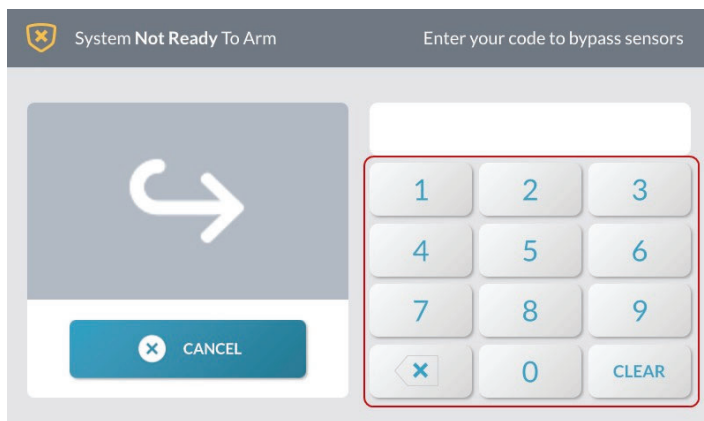

3. When the system status message changes to **System Ready to Arm (BYPASS)**, you can arm the system. See “Arm the System.”

## Canceling a Bypassed Sensor

To remove a sensor from the Bypassed Sensor list:

1. Tap the circle indicator showing how many devices are currently bypassed.

*Bypassed Sensors Indicator*

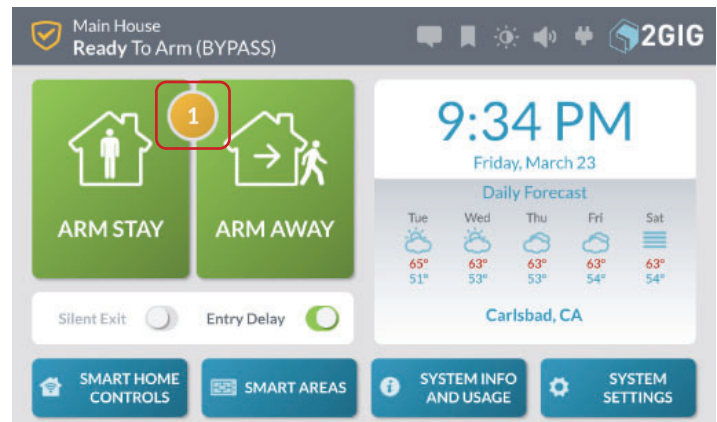

2. Below the Bypassed Sensors list, tap **Cancel Bypass**.

*Bypassed Sensors > Cancel Bypass Button*

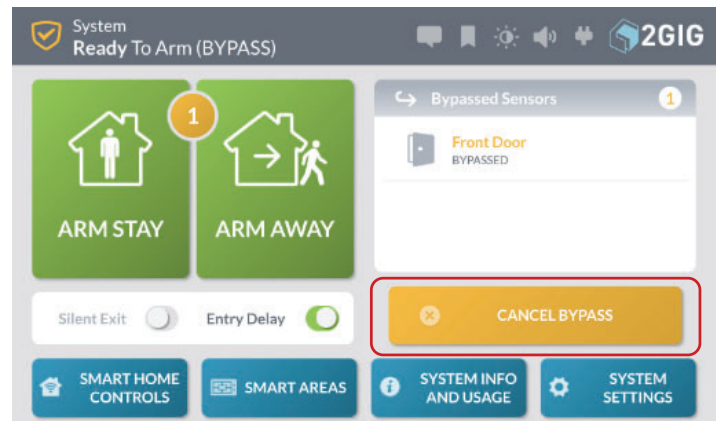

3. At the **Enter your code to cancel bypass** screen, enter an active, four-digit user code.

*Enter Your Code to Cancel Bypass*

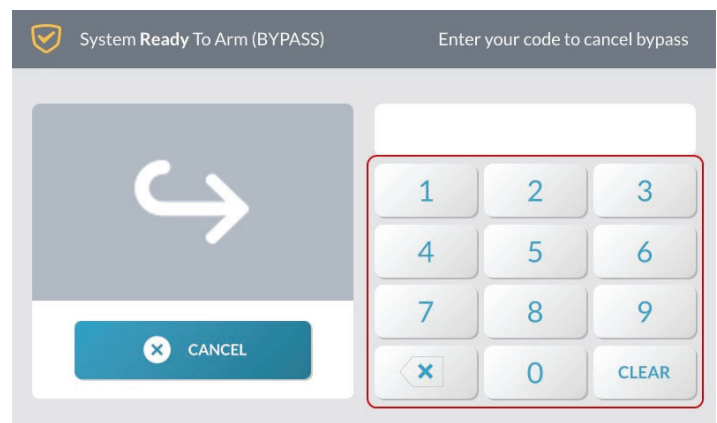



This changes the system's status back to *System Not Ready to Arm* and moves the sensor to the **Sensors Not Ready** list.

*System Not Ready to Arm—Sensors Not Ready List*

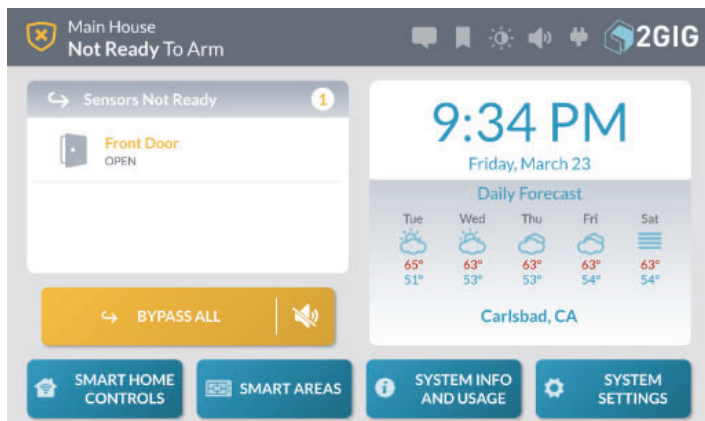

## Use the Quick Exit Button

The **Quick Exit** button gives users the ability to start an *Exit Delay* countdown while the system is armed. This gives users the ability to leave the premises through an *Exit/Entry* door, instead of having to disarm and then rearm the system. When the *Allow Quick Exit* setting is enabled, the **Quick Exit** button appears on the **System Armed (STAY)** screen.

**NOTE:** Consult your installer to determine if the Allow Quick Exit setting is enabled or disabled on the system.

To use the **Quick Exit** button:

1. Arm the system in Stay Mode. See “Arm the System.”
2. At the **System Armed (STAY)** screen, tap **Quick Exit**.

*System Armed—Quick Exit Button*

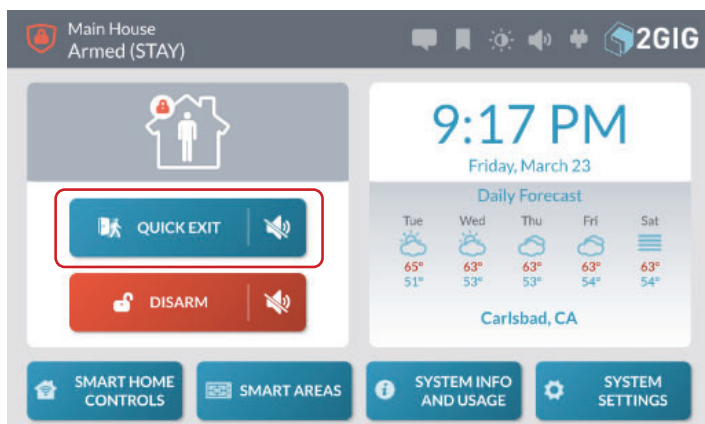

This starts the *Exit Delay* countdown to give you time to exit through an *Exit/Entry* door without having to re-arm the system. At the end of the countdown, the system arms itself in the appropriate mode.

## In the Event of an Exit Error

If you arm the system and an *Exit/Entry* door is left in a violated state or condition at the time the *Exit Delay* countdown expires (for example, the door you exit from doesn't close behind you), the GC3 Panel sounds the local alarm and the *Entry Delay* countdown begins. If you do not disarm the system when the *Entry Delay* countdown begins, the system automatically begins the alarm transmission sequence. The panel also transmits an *Exit Error* report to the Central Station and displays an *Exit Error* message on the panel screen, as shown below.

*Alarm Transmission & Exit Error Sequence*

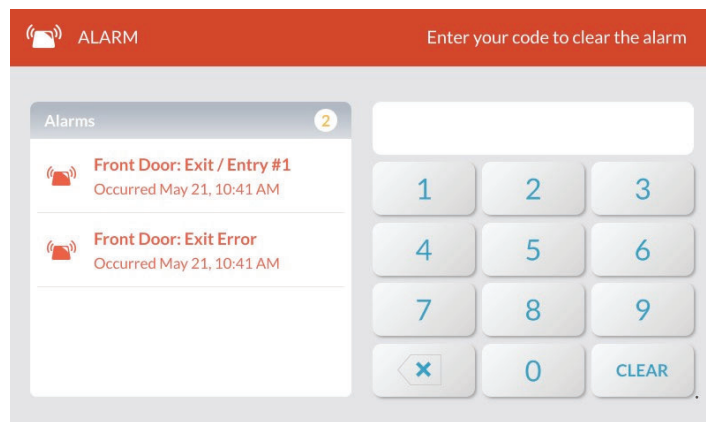

## To Disarm the System

To turn the system's burglary protection sensors OFF, you disarm the system. Disarming the system also silences any type of alarm that might be sounding.

**NOTE:** To use this feature, you must have an active, four-digit user code. See your system's Master User to obtain a code.

## Disarm the System (Stay Mode)

When the system is armed in Stay Mode, any person with an active, four-digit user code can disarm the system.

To disarm the system:

1. At the **System Armed** screen, tap **Disarm**.

*System Armed > Disarm Button*

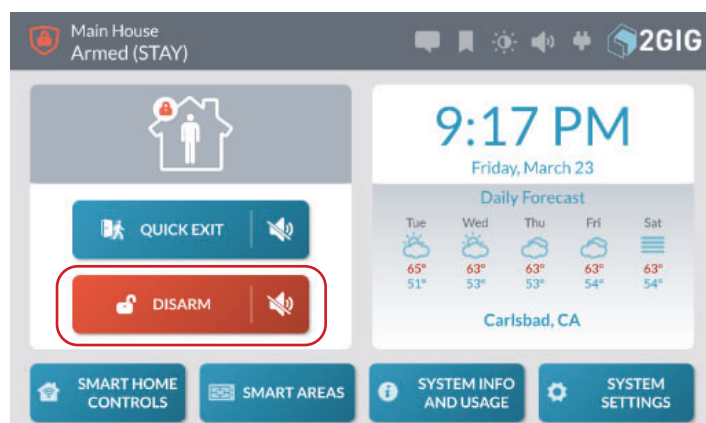

**TIP:** If you want to exit the premises through one of the Exit/Entry doors while the system is armed in Stay Mode, tap the **Quick Exit** button . See “Use the Quick Exit Button” on the previous page.

- At the **Enter your code to disarm the system** screen, enter an active, four-digit user code. You must enter a code before the *Entry Delay* countdown expires.

*Enter Your Code to Disarm the System*

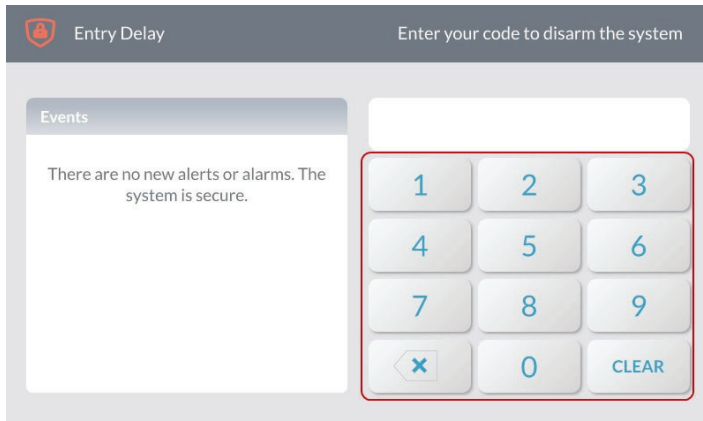

**NOTE:** Consult your installer to determine how the *Entry Delay* feature is configured on your system (30-240 seconds).

The system is disarmed. If protected doors and windows are closed, the system sounds the *System Disarmed, Ready to Arm* announcement. If protected doors or windows are open, the system sounds the *System Disarmed Not Ready to Arm* announcement.

### Disarm the System (Away Mode)

When the system is armed in Away Mode, any person with an active, four-digit user code can disarm the system. You must enter the code before the *Entry Delay* countdown expires to avoid setting off the alarm.

To disarm the system from Away Mode:

- Enter the premises using one of the Exit/Entry doors. The system's *Entry Delay* beeps sound.

**NOTE:** Consult your installer to determine how the *Entry Delay* feature is configured on your system (30-240 seconds).

- At the **Entry Delay** screen, enter an active, four-digit user code. You must enter your code before the *Entry Delay* countdown expires.

*Enter Your Code to Disarm the System*

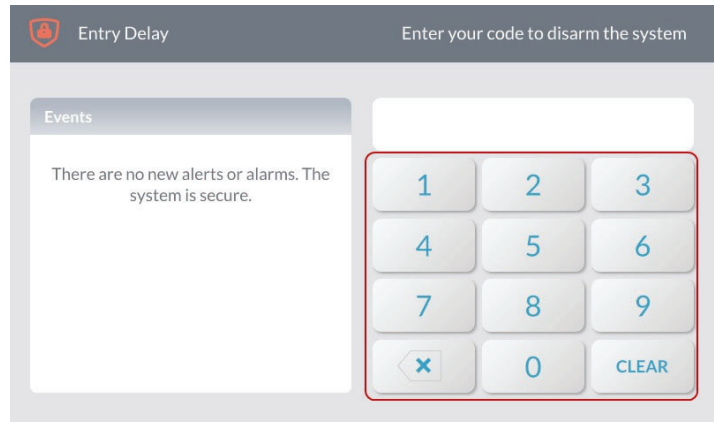

The system is disarmed. If protected doors and windows are closed, the system sounds the *System Disarmed, Ready to Arm* announcement. If protected doors or windows are open, the system sounds the *System Disarmed Not Ready to Arm* announcement.

### Transmit a User Duress Report

You can enter the Duress Code to transmit a user duress report to the Central Station without alerting an intruder that you are calling for help.

### Transmitting a User Duress Report when the System is Armed

To transmit a user duress report when the system is armed:

- At the **System Armed** screen, tap **Disarm**.

*System Armed—Disarm Button*

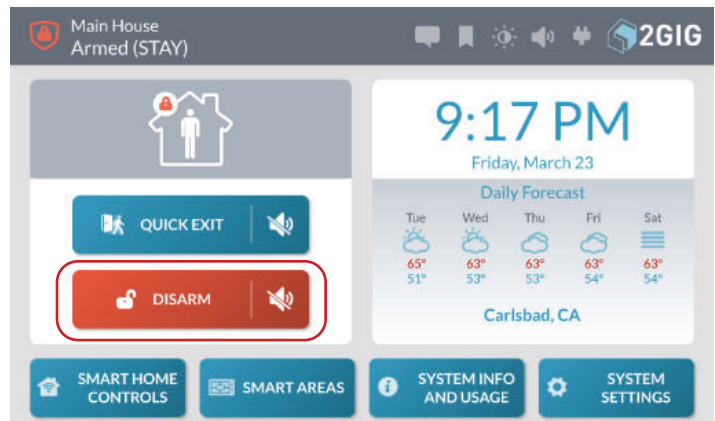

- Enter the four-digit Duress Code.

### Enter the Duress Code

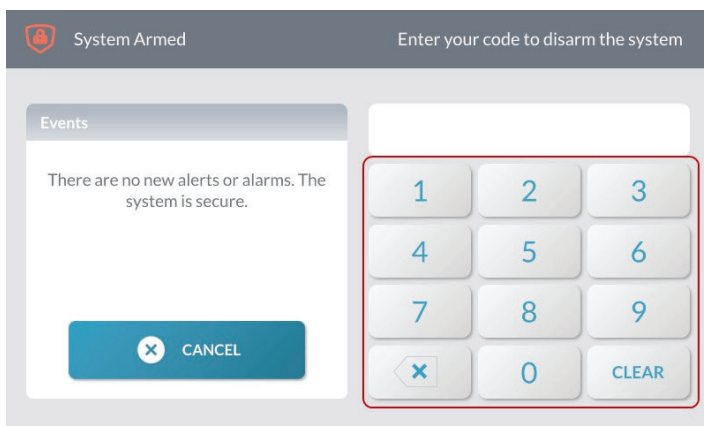

The system disarms and transmits a silent duress report to the Remote Service Provider.

### Transmitting a Duress Signal when the System is Disarmed

To transmit a user duress report when the system is disarmed:

1. At the Home screen or from one of the menus, tap the system logo.

#### System Logo



2. At the **Enter your code to disarm the system** screen, enter the four-digit Duress Code.

### Enter the Duress Code

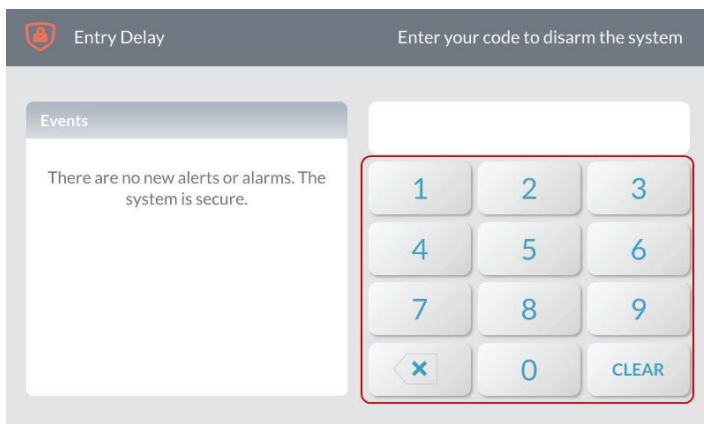

The system will announce “System Disarmed” and return to the **Home** screen.

### In the Event of a Burglary Alarm

If one or more armed sensors are tripped while the system is armed in Stay or Away Mode, an alarm condition will occur, and the system’s alarm siren will sound.

If an *Entry Delay* sensor is tripped while the system is armed in Stay or Away Mode, the *Entry Delay* countdown starts to give you time to disarm the system. If the system is not disarmed before the countdown expires, an alarm condition occurs, and the system’s alarm siren will sound.

If more than one armed sensor is tripped, the system displays the triggered sensors in chronological order.

#### Alarms Screen—Multiple Alarms in Chronological Order

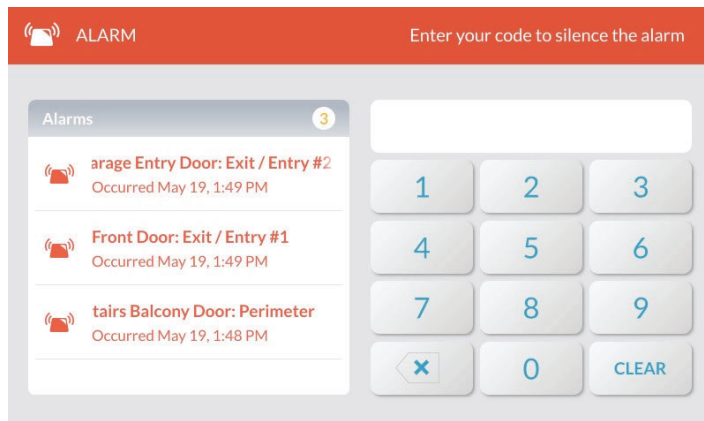

### Silencing the Alarm Sounder (for False Alarms)

If the system is in an active alarm state, any person with an active, four-digit user code can silence the sounder by disarming the system.

- » If you disarm the system **BEFORE** the **Abort Window Dialer Delay** countdown expires, the system cancels the alarm and stops the alarm report from being transmitted to the Central Station.
- » If you disarm the system **AFTER** the **Abort Window Dialer Delay** countdown expires, the system silences the alarm and transmits an alarm cancellation report to the Central Station.

**NOTE:** Consult your installer to determine how the *Alarm Abort Window Dialer Delay* feature is configured on your system (15-45 seconds). This setting specifies the number of seconds end users have to manually abort the alarm, in the event of a false alarm. For *ANSI/SIA CP-01-2010* compliance, the default setting is 30 seconds. For *UL 1023: Household Burglar Alarm Units* compliance, this setting may be configured to a maximum of 45 seconds.

To silence the alarm sounder:

1. When an **Alarm** is sounding, enter an active, four-digit user code.

## Enter Your code to Silence the Alarm Screen

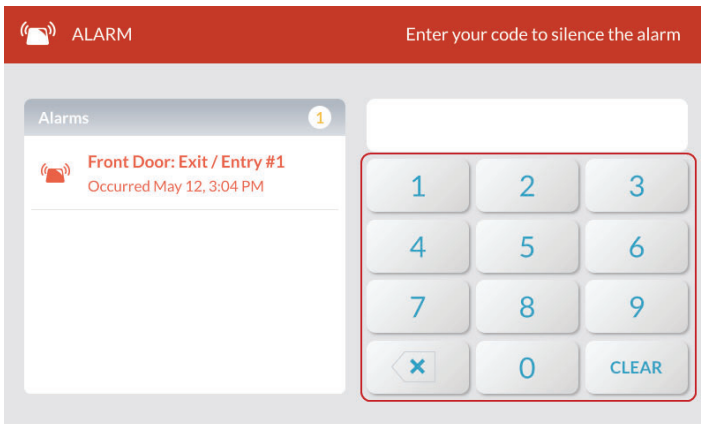

2. Depending on how quickly you enter your code, one of the following occurs:
  - a. If you enter your code before the *Abort Window Dialer Delay* countdown expires, the following message appears.

### Disarming Canceled an Alarm Before it was Transmitted Message

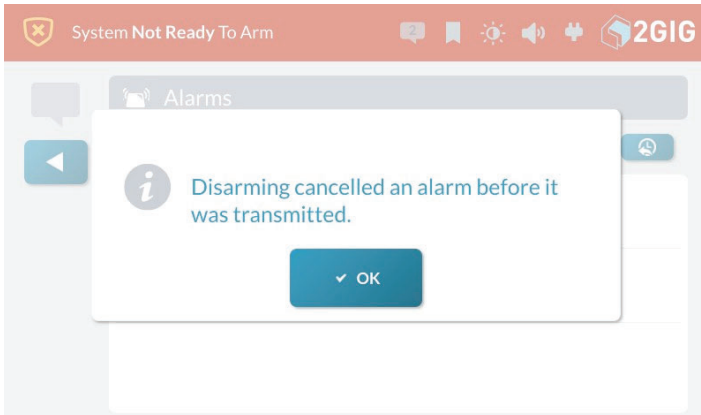

- b. If you enter your code after the *Abort Window Dialer Delay* countdown expires and before the *Alarm Cancel Time* expires, the following message appears.

### Alarm Report Already Transmitted...Cancel Being Sent Message

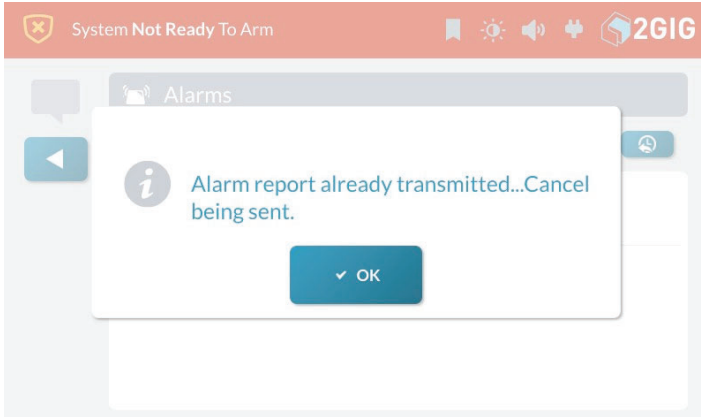

3. Tap **OK** to dismiss the notification message.

## Clearing an Alarm

If an alarm occurs while you are away, the GC3 Panel's Piezo Sounder will sound for a preset amount of time (as defined by the Burglary Bell Cutoff Time and/or the Fire Bell Cutoff Time). Upon entering the premises, the system emits fast, repeated beeps to warn you that an alarm was set off while you were away.

**NOTE:** Consult your installer to determine how the *Burglary Bell Cutoff Time* and *Fire Bell Cutoff Time* is configured on your system. The time can be configured to last *4 minutes*, *8 minutes*, *12 minutes*, *16 minutes*, or *Unlimited* (no cutoff). The default setting for both features is four (4) minutes.

**CAUTION!** If the system emits fast, repeated beeps (instead of the typical *Entry Delay* beeps), proceed indoors with extreme caution. For your safety, it is recommended that you immediately leave the premises, go to a secure location, and then contact your local authorities for assistance. If you have any reason to believe an intruder is present, do NOT enter the premises until the dwelling is deemed safe by local authorities.

To clear an alarm:

1. At the **Alarm** screen (after the *Burglary Bell Cutoff Time* or *Fire Bell Cutoff Time* expires), enter an active, four-digit user code.

### Enter Your Code to Clear the Alarm

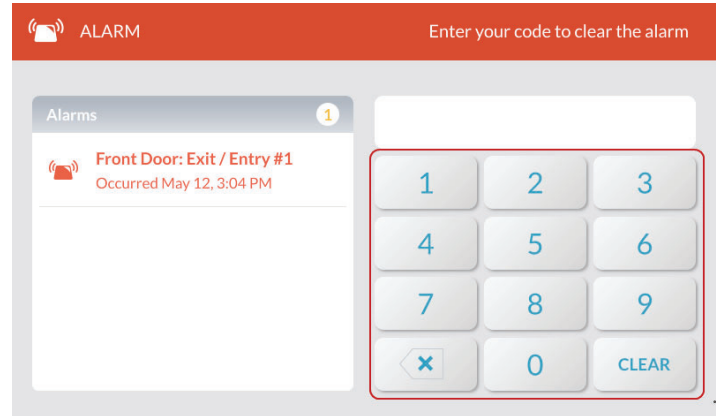

2. Depending on how quickly you enter your code, one of the following occurs:
  - a. If you enter your code before the *Alarm Cancel Time* countdown expires, the following message appears.

## Alarm Report Already Transmitted ... Cancel Being Sent Message

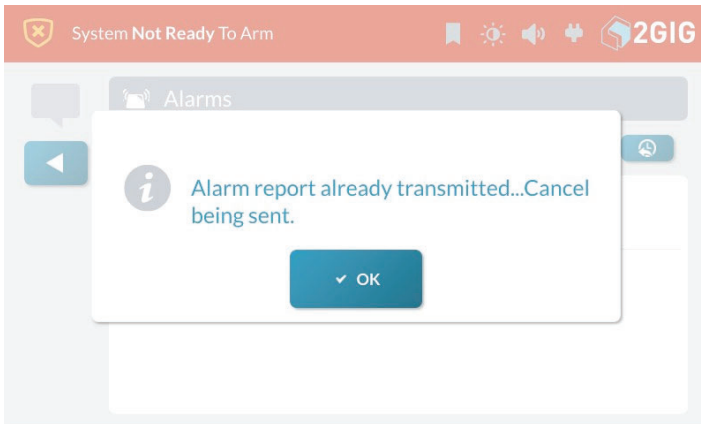

**NOTE:** Consult your installer to determine how the *Alarm Cancel Time* setting is configured on your system. For compliance with *ANSI/SIA CP-01-2010*, the factory default setting is five (5) minutes.

- b. If you enter your code after the *Alarm Cancel Time* countdown expires, the system reveals the **Alarm History**.

## Alarm History

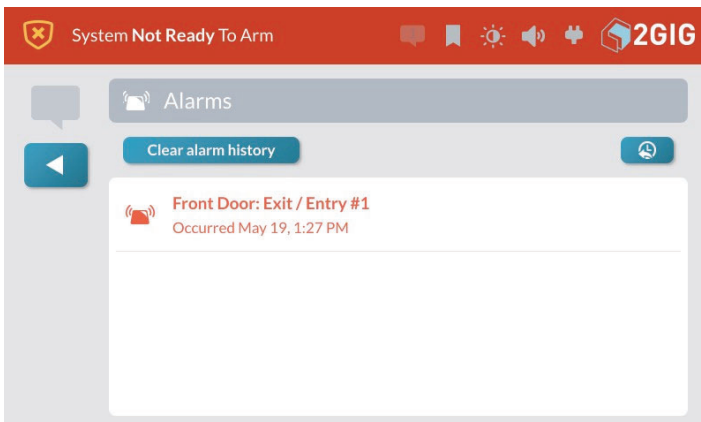

The system clears the alarm. You can also clear the Alarm History. See "Clear the Alarm History."

# Fire and Carbon Monoxide Protection

## Overview

During setup, a professional installer typically configures a variety of wireless and wired sensors to provide the dwelling with continuous, 24-hour-a-day, heat, smoke, and gas protection. Most systems are installed with both Wireless Smoke/Heat/Freeze Alarms and Wireless Carbon Monoxide Detectors.

## Important Concepts

To help you get the most out of your fire, heat, and gas protection system, it is useful to understand these concepts.

## National Fire Alarm and Signaling Code

**IN THE UNITED STATES, CANADA, AND OTHER COUNTRIES REQUIRED TO MEET THIS STANDARD: THIS EQUIPMENT MUST BE INSTALLED IN ACCORDANCE WITH CHAPTER 2 of ANSI/NFPA 72: National Fire Alarm and Signaling Code (National Fire Protection Association, Batterymarch Park, Quincy, MA 02269).**

**IMPORTANT:** This system ships with an approved 24-hour backup battery installed and is compliant with *UL 985: Household Fire Warning System Units*.

**IMPORTANT:** Specific requirements for Heat and Smoke Alarms vary from state to state and from region to region. A professional installer must always verify current requirements for your area with the local Fire Department.

**NOTE:** Instructions describing the proper installation, operation, testing, maintenance, evacuation planning, and repair service are provided in the printed *Installation Instructions* included with all 2GIG Wireless Smoke/Heat/Freeze Alarms and Wireless Carbon Monoxide Detectors.

## Recommended Smoke Alarm Placement

Early warning fire detection is best achieved when fire detection equipment is installed in all rooms and areas of the premises. Equipment should be installed as follows:

### Recommended Smoke Alarm Placement

**A** A smoke alarm should be located between the sleeping area and the rest of the family living unit.

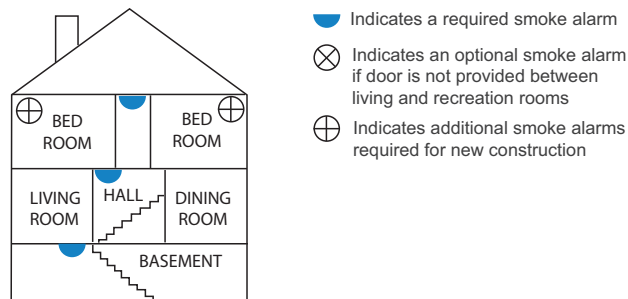
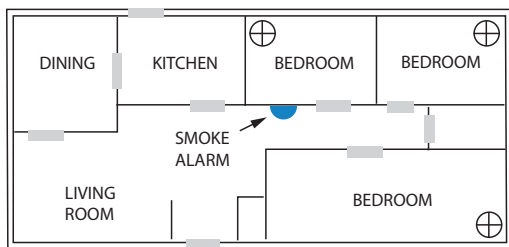

**C** A smoke alarm should be located on each story.

**B** In family living units with more than one (1) sleeping area, a smoke alarm should be provided to protect each sleeping area.

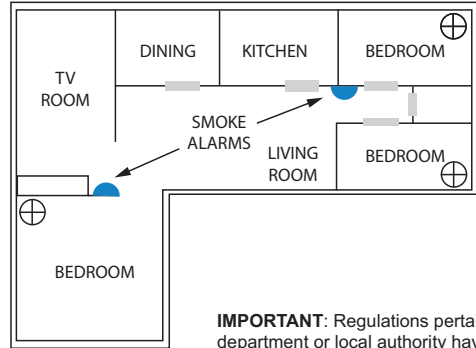

**IMPORTANT:** Regulations pertaining to smoke alarm installations vary. For more information, contact your local fire department or local authority having jurisdiction.

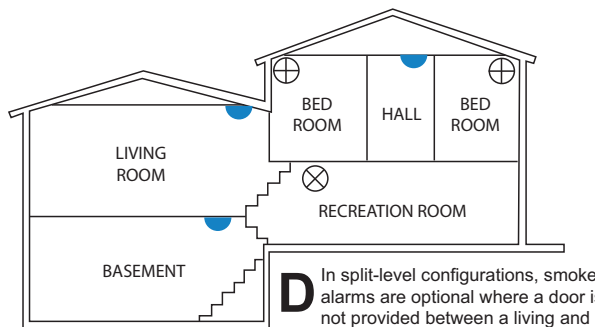

**D** In split-level configurations, smoke alarms are optional where a door is not provided between a living and recreation room.

---

## Emergency Action Plan

Establish and regularly practice a plan of escape with all members of your household in the event of fire. The National Fire Protection Association recommends the following steps:

1. Mount your detector or your interior or exterior alarm sounders where they can be heard by all occupants.
2. Determine two means of escape from each room. One path of escape should lead to the door that permits normal exit from the building. The other should be an alternate escape, such as a window, should the path to the escape door be impassable. Station an escape ladder at such windows if there is a long drop to the ground.
3. Sketch a floor plan of the building. Show windows, doors, stairs, and rooftops that can be used to escape. Indicate escape routes for each room. Keep these routes free from obstructions and post copies of the escape routes in every room.
4. Ensure that all bedroom doors are shut while you are asleep, preventing deadly smoke from entering while you escape.
5. Touch the door before opening it. If the door is hot, check your alternate escape route. If the door is cool, open it cautiously. Be prepared to slam the door shut if smoke or heat rushes in.
6. When smoke is present, crawl on the ground. Do not walk upright, since smoke rises and may overcome you. Air is typically clearest near the floor.
7. Escape quickly, but don't panic.
8. Establish a place outdoors, away from your house, where everyone can meet and then take steps to contact the authorities and account for those missing. Ensure that nobody returns to the premises.

## In the Event of a Fire Alarm

Smoke and Carbon Monoxide (CO) detectors may be installed to protect the occupants of the dwelling from the harmful, and possibly deadly effects of smoke, heat, and fire-related dangers. The system's fire and emergency protection features are always protecting the premises.

**NOTE:** A professional installer must ensure that all Smoke/Heat Alarms are installed in compliance with all national, regional, and local laws, statutes, and guidelines.

## Silence a False Fire Alarm

In the event of a false fire alarm (for example, burning food or another non-emergency condition), you can silence the alarm.

To silence the alarm:

1. Enter an active, four-digit user code to silence the alarm.

**IMPORTANT:** Consult your installer to determine how the *Abort Window Dialer Delay* is configured on your system. This defines the amount of time the system will wait to initiate the digital dialer when an alarm condition is triggered and specifies the number of seconds you have to manually abort the alarm, before an alarm report is sent to the Central Station.

**IMPORTANT:** Consult your installer to determine how the *Alarm Cancel Time* is configured on your system. This defines the amount of time you have to send an alarm cancellation report to the Central Station. expires. The factory default setting for the system is five (5) minutes.

2. Review the Alarms screen to determine which sensor activated the alarm.

**NOTE:** If the alarm restarts, smoke may be present in the alarm's detection chamber. Enter the user code again. Then fan the detection chamber on the sensor for 30 seconds.

3. After the problem has been addressed, tap the **Clear Alarm History** button.

**NOTE:** For Smoke/Heat Alarms and CO Detectors, the **Clear Alarm History** button will not permit you to clear any history until the GC3 Panel receives a message from the sensor that it has returned to normal operations.

**NOTE:** If Smart Areas are configured, the Fire Alarm must be acknowledged and cleared in each Smart Area. This can be done at a keypad assigned to that area or by using the **Smart Areas** button on the home screen.

## In the Event of a Carbon Monoxide Alarm

Detectors may have been installed to safeguard the occupants of your dwelling from the dangerous and possibly deadly effects of CO gas. See “Safety Precautions and Notations.”

If a CO alarm is activated, the system emits a warning siren until the system no longer detects CO in the environment.

To respond to a CO alarm event:

1. Gather all occupants and immediately move to fresh air (either go outdoors or stand by an open door/window).

**DANGER!!!** To protect yourself and others from injury and/or death, do not re-enter the home or move away from the open door/window until the premises has been approved for safe reentry by emergency officials. To learn about other ways to safeguard your home from the harmful effects of CO, refer to the guidelines defined by your local, state, or regional officials.

2. Dial 9-1-1 (or your region’s emergency services number) to report the situation to authorities.  
Always call from safe location.

3. Survey each person’s health, checking for flu-like symptoms and other evidence of CO poisoning.

**TIP:** To prevent a future occurrence, contact an industry professional to evaluate all possible sources of CO gas in the dwelling.

**NOTE:** If Smart Areas are configured, the CO Alarm must be acknowledged and cleared in each Smart Area. This can be done at a keypad assigned to each area or by using the Smart Areas button on the home screen.

## Clear the Alarm History

After an alarm is activated on the system while you are away, a notification message appears in the **Alarm History**.

To clear the alarm history:

1. Tap the **Message** system icon. Then tap **Alarms**.

*New Alarms*

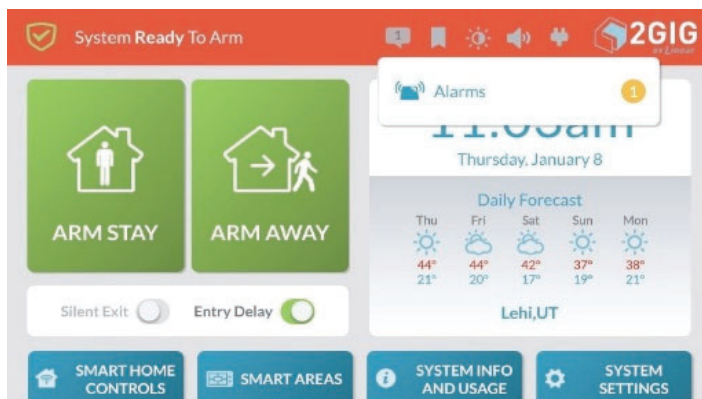

2. Review the **Alarms** list. Then tap **Clear Alarm History**.

*Alarms Screen*

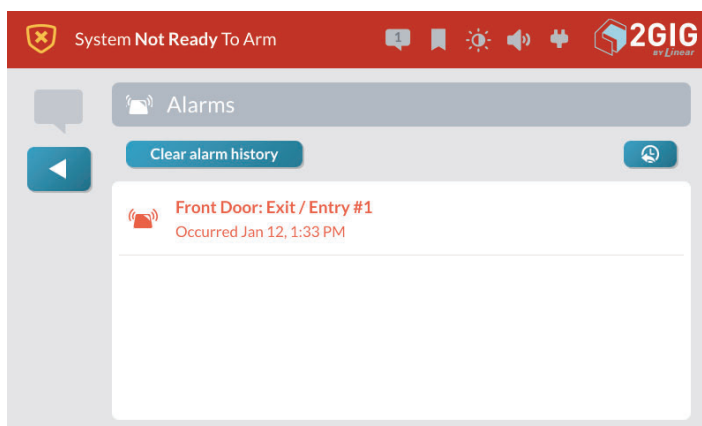

## Emergency Features

### 24-Hour Alarm Buttons

Three 24-hour alarm buttons can be shown or hidden by the installer on the Control Panel’s touchscreen: **Panic**, **Fire**, and **Emergency**.

**NOTE:** Consult your installer to show or hide the 24-Hour Emergency Alarm Buttons on your system. Typically, all of these buttons are configured to display on the touchscreen default. However, some systems are not configured to reveal all of the buttons.

You can open the following screen by pressing the **Alarm** button on the Control Panel. See “Activate a Manual Panic, Fire, or Emergency Alarm” below. This reveals a screen that is typically configured by installers to include these 24-hour emergency alarm buttons:

*24-Hour Alarm Buttons*

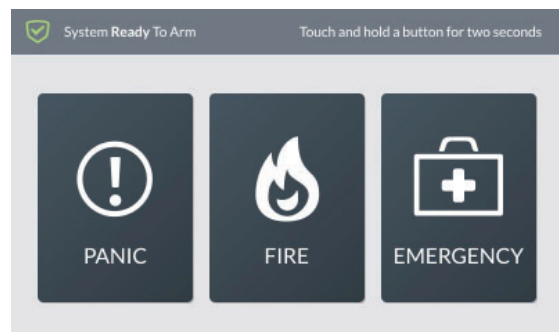

### Panic Button

When a user touches and holds the **Panic** button for two (2) seconds, the system immediately goes into the alarm state. Depending on how the system is configured, the Control Panel emits a loud, patterned warning siren or sets off a silent panic alarm with no siren. The system also transmits a police report to the Central Station.



**NOTE:** Consult your installer to determine if the *Police Emergency Key* is configured to sound an audible alarm or a silent panic alarm.

**NOTE:** Consult your installer to determine if the *2-Way Voice* feature is enabled on the system. If enabled, setting off the Panic alarm gives operators at the Central Station the ability use the Control Panel's built-in speaker and microphone to converse with people on the premises.

**NOTE:** Consult your installer to determine if the *Silent Panic/Burglary Listen Only* feature is enabled on the system. If enabled, setting off the Panic alarm gives operators at the Central Station the ability to use the Control Panel's built-in microphone to listen. If the panic alarm is sent, the operator can only listen. For your protection, you and the operator will not be able to talk.

## Fire Button

When a user touches and holds the **Fire** button for two (2) seconds, the system immediately goes into the alarm state. The Control Panel emits a loud, patterned warning siren that is in compliance with *ANSI S3.41 Temporal-3 Fire Alarm Signal* and continues to sound until the system is disarmed (see "To Disarm the System") or the Fire Bell Cutoff Time expires. The system also transmits a Fire Report to the Central Station.

**NOTE:** Consult your installer to determine how the Fire Bell Cutoff Time is configured on your system. The time can be configured to last *4 minutes, 8 minutes, 12 minutes, 16 minutes, or Unlimited* (no cutoff). The default setting is four (4) minutes.

**NOTE:** If Smart Areas is enabled the Fire Button will create a global alarm in all Smart Areas. The alarm must be acknowledged/cleared in each Smart Area.

## Emergency Button

When a user touches and holds the Emergency button two (2) seconds, the system immediately goes into the alarm state. The Control Panel emits a loud, patterned warning siren and continues to sound until the system is disarmed (see "To Disarm the System"). The system also transmits an Emergency Report to the Central Station.

## Activate a Manual Panic, Fire, or Emergency Alarm

You can activate a panic, fire, or emergency alarm using the GC3 Panel.

To activate a manual alarm:

1. Press the **Alarm** button on the GC3 Panel.

*GC3 Panel—Alarm Button*

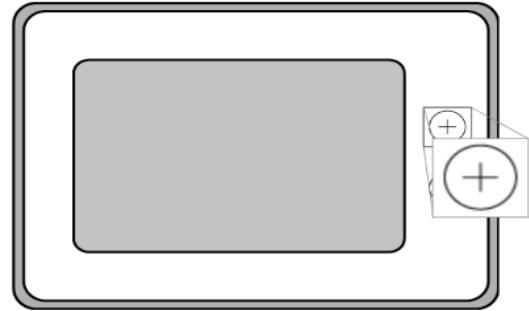

2. Touch and hold the **Panic, Fire, or Emergency** button for two (2) seconds.

*24-Hour Alarm Buttons*

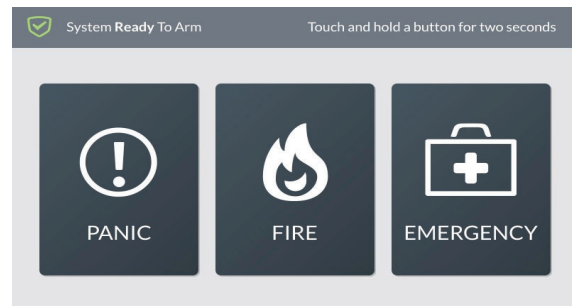

**NOTE:** Consult your installer about your system's emergency key settings. Typically, all three buttons are enabled and visible on the touchscreen by default. However, some systems may be configured to hide one or more of these buttons.

## Remote Control

### Remote Control Devices

The installer can pair your system with one or more wireless key fobs to give you the ability to arm/disarm your system away from, but within range of, the control panel using the key fob's buttons. The GC3 Security & Automation System can be paired to work with a maximum of 32 wireless key fobs. Depending on your individual needs, key fobs can also be configured by the installer to activate specific alarms.

### Operate the System with a Key Fob

The installer can configure each key fob to let you perform up to five (5) remote functions:

- » **Arm the System in Stay Mode**
- » **Arm the System in Away Mode**
- » **Disarm the System**
- » **Activate an Auxiliary Function**
- » **Activate an Alarm**

**NOTE:** Consult your installer to determine how your keyfob is configured to work with the system. Depending on your key fob's setting, it may or may not be configured to disarm the system.

### Arming the System Using a Keyfob

You can arm the system in Stay or Away mode using a key fob that has been paired with the system.

- » **To arm the system in Stay Mode**, press the **Stay** button on the key fob for two (2) seconds.
- » **To arm the system in Away Mode**, press the **Away** button on the key fob for two (2) seconds.

**NOTE:** Depending on setup options, if any perimeter doors or windows are open, the system may not allow arming to Away mode with a wireless key fob. Consult your installer to determine how this option is configured on your system.

### Disarming the System Using a Key Fob

To disarm the system, press and hold the **Disarm** button on the key fob for two (2) seconds.

**NOTE:** Consult your installer to determine how your keyfob is configured to work with the system. Depending on the individual key fob settings, it may or may not be configured to disarm the system.

### Activating an Auxiliary Function

To activate an auxiliary function, press and hold the **Auxiliary** button on the key fob for two (2) seconds.

**NOTE:** Consult your installer to determine how your keyfob is configured to work with the system. Depending on the individual key fob settings, it may be configured to set of an external siren/sounder, control a lock, control a light, or used to activate a different auxiliary function.

## Activating an Alarm Using a Key Fob

To activate an emergency alarm, press and hold both the **Away** and **Disarm** buttons on the keyfob for five (5) seconds.

**NOTE:** Consult your installer to determine what type of alarm your keyfob is configured to activate. Depending on the individual key fob settings, this function might be disabled on your key fob, or it might be configured to activate an auxiliary, audible, or silent panic alarm.

**NOTE:** In order to cancel an emergency alarm activated with a key fob, you must disarm the system at the GC3 Panel.

**NOTE:** If **Smart Areas** is enabled, a keyfob can be configured to perform Arm/Disarm/Alarm functions on one Smart Area.

## Smart Home Controls

### About the Smart Home Controls Menu

The Smart Home Controls menu gives users the ability to control Z-Wave smart home devices at the GC3 Panel. The system supports a maximum of 232 Z-Wave devices.

### Navigate to the Smart Home Controls Menu

To navigate to the **Smart Home Controls** menu:

1. At the Home screen, tap **Smart Home Controls**.

*Home > Smart Home Controls*

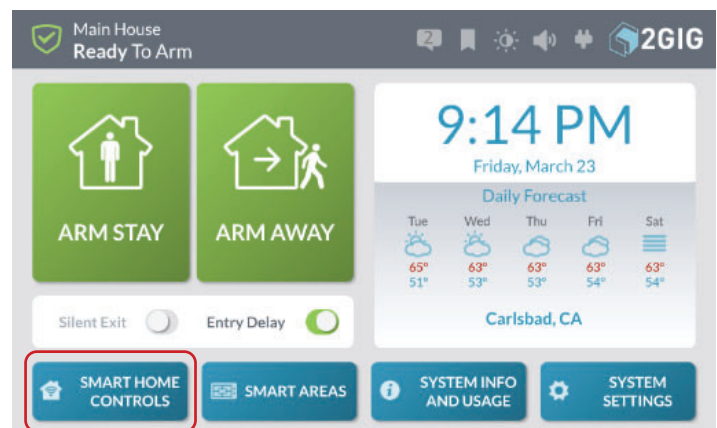

This reveals the **Smart Home Controls** menu.

*Smart Home Controls Menu*

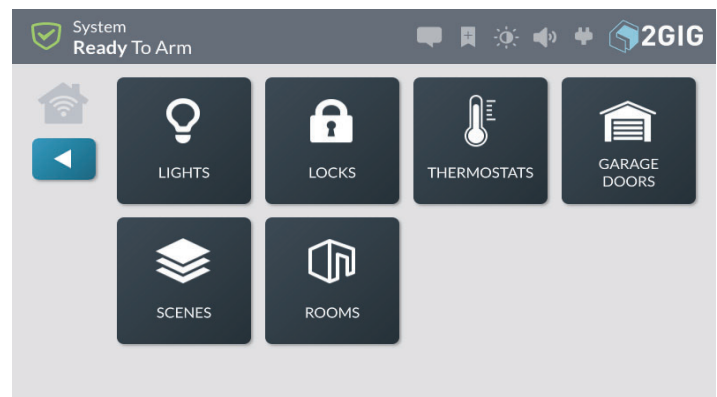

## Lights

Use the controls in the **Lights** screen to adjust your smart home lighting devices.

### Dim or Brighten Lights

To dim or brighten lights:

1. Navigate to the **Smart Home Controls** menu. See “Navigate to the Smart Home Controls Menu” above.

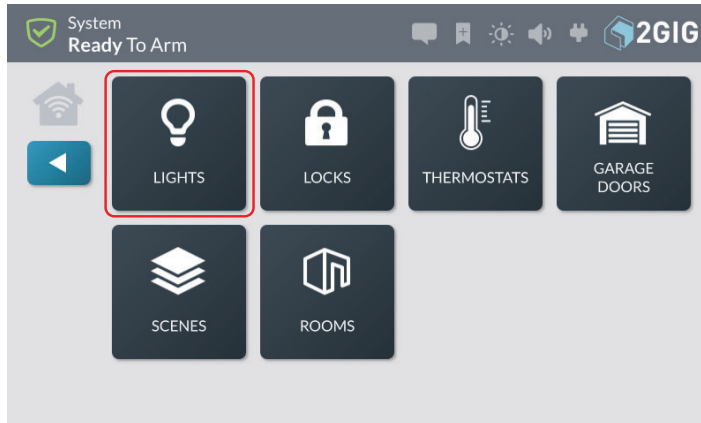

2. Tap **Lights**.
3. At the **Lights** screen, swipe left to dim the light or right to brighten. You can also tap the dim or brighten icon.

#### Lights Screen

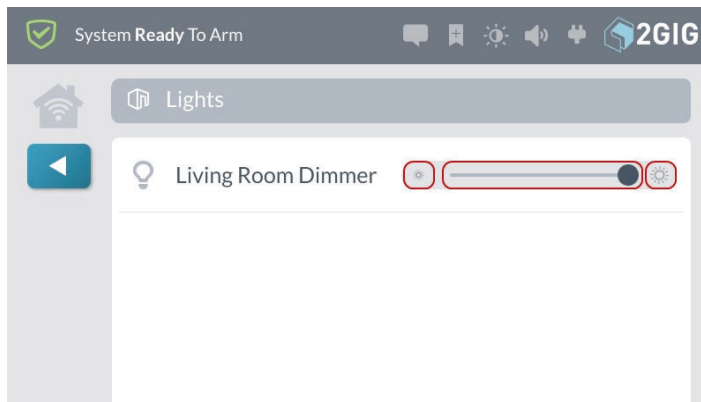

## Locks

Use the controls in the **Locks** screen to lock and unlock your smart home devices.

To lock and unlock devices:

1. Navigate to the Smart Home Controls menu. See “Navigate to the Smart Home Controls Menu” above.
2. Tap **Locks**.
3. At the **Locks** screen, swipe left to unlock or right to lock. You can also tap the lock or unlock icon.

## Thermostats

Use the controls in the **Thermostats** screen to operate your thermostats. To operate the thermostat:

1. Navigate to the **Smart Home Controls** menu. See “Navigate to the Smart Home Controls Menu.”
2. Tap **Thermostats**.
3. At the **Thermostats** screen, you have these options:

#### Thermostats Screen

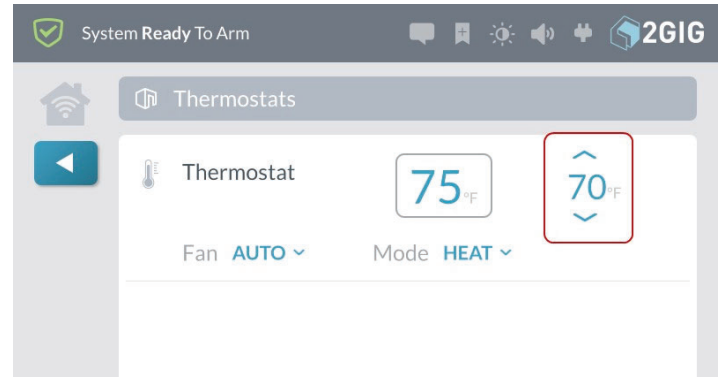

- » To change the temperature set points, press the top arrow to raise the temperature or press the bottom arrow to lower the temperature.

#### Temperature Set Point

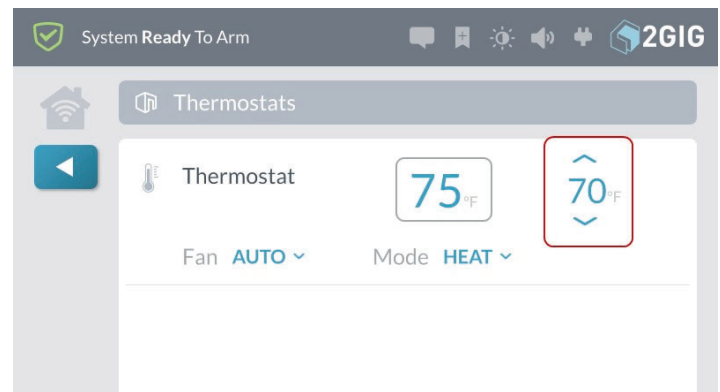

- » To change the fan setting, tap the current setting to open a menu and tap the desired option.

#### Fan Setting

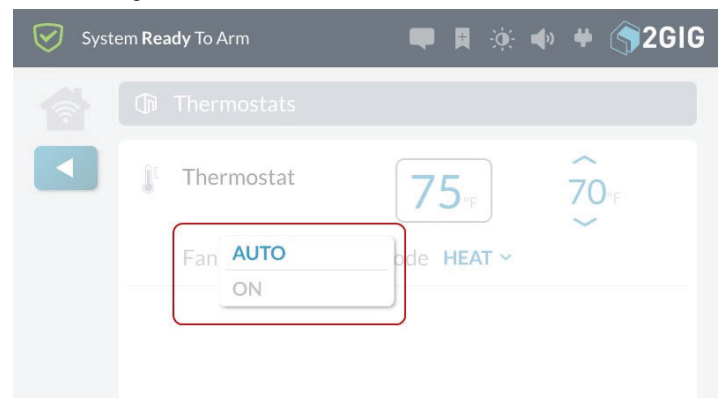

- » To change the thermostat mode, tap the current setting to open a menu and tap the desired mode.

## Garage Doors

Use the controls in the **Garage Doors** screen to open and close garage doors. To operate the Garage Door controller:

1. Navigate to the **Smart Home Controls** menu. See “Navigate to the Smart Home Controls Menu.”
2. Tap **Garage Doors**.

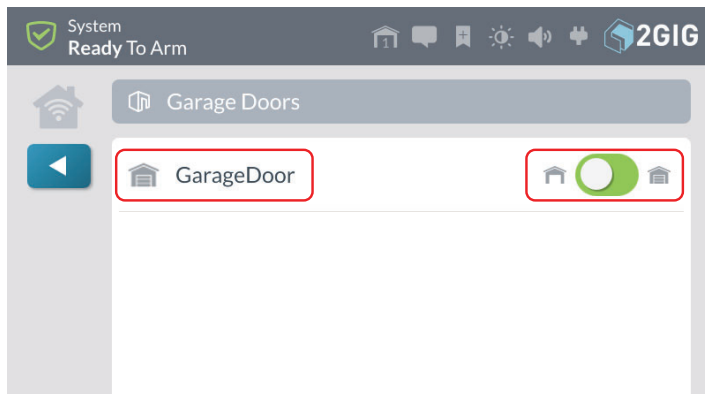

3. At the **Garage Door** screen press the toggle to open or close the Garage Door.

## Scenes

**NOTE:** Consult your dealer to determine if this feature is available or to have it turned ON.

Use the **Scenes** screen to create scenarios that define simple rules for how your Z-Wave home automation devices work together. There is no functional limit on the number of scenes that you can create to control lights, home automation devices, and other alarm sensors.

*Smart Home Controls > Scenes*

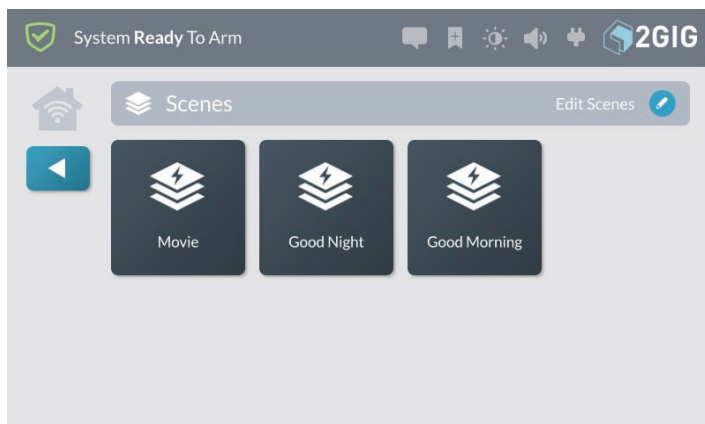

### Examples: When to Create Scenes

There are a wide variety of scenes that you can create. Some of the more common include:

- » **Leaving for the Day:** Create a scene named “Leave” to lock the door, turn off all lights, adjust the thermostat.
- » **Retire for the Night:** Create a scene name “Good Night” to switch OFF the downstairs lights, lock the entry doors, illuminate a nightlight in the dwelling’s hallways, and adjust the thermostat setting.

- » **Wake Up in the Morning:** Create a scene named “Good Morning” to adjust the thermostat temperature, turn on family room lights, and turn on the coffee pot.

## Add a New Scene

To add a new scene:

1. Navigate to the **Smart Home Controls** menu. See “Navigate to the Smart Home Controls Menu” at the beginning of the **Smart Home Controls** section.
2. At the **Smart Home Controls** menu, tap Scenes.
3. At the **Scenes** screen, tap **Edit Scenes**.

*Scenes > Edit Scenes*

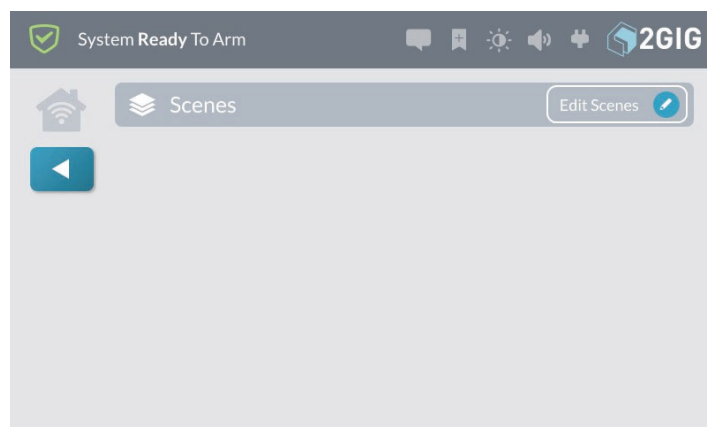

4. At the **Scenes** screen, tap **Add New Scene**.

*Add New Scene*

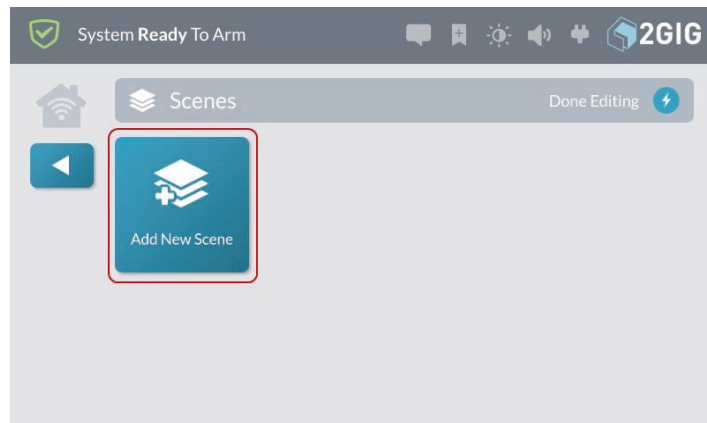

5. Enter a name for the new scene. Then tap **Next**. For example, enter: **Lock Up**.

Enter a Name for the New Scene

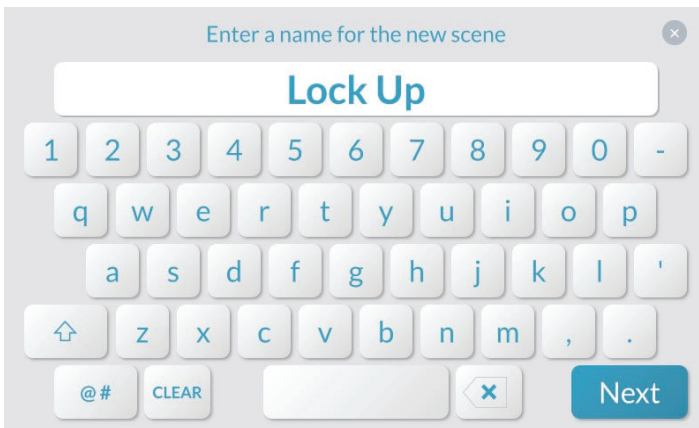

6. Create a new scene (see “Add a New Scene” on the previous page) or tap the **Scene** that you want to edit.
7. At the **<Scene Name>** screen, tap **Add or Remove Items**.

*Edit Scene > Add or Remove Items*

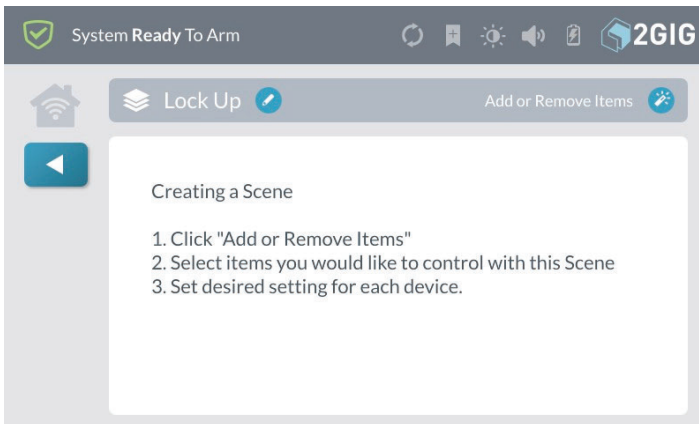

8. Tap the arrow that corresponds to the desired smart home control.

For example, tap the arrow next to *Lights*.

*Add or Remove Items > Lights*

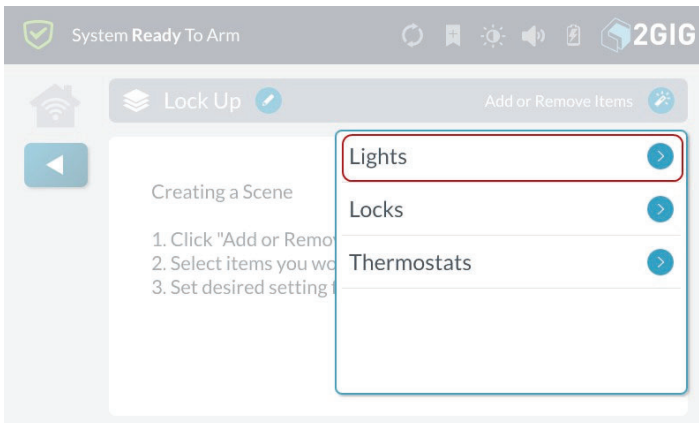

9. Tap the plus (+) sign that corresponds to the desired device in the list.

For example, tap the plus (+) sign next to the device named *Home Theater Light*.

*Add or Remove Items > Lights > Add Device*

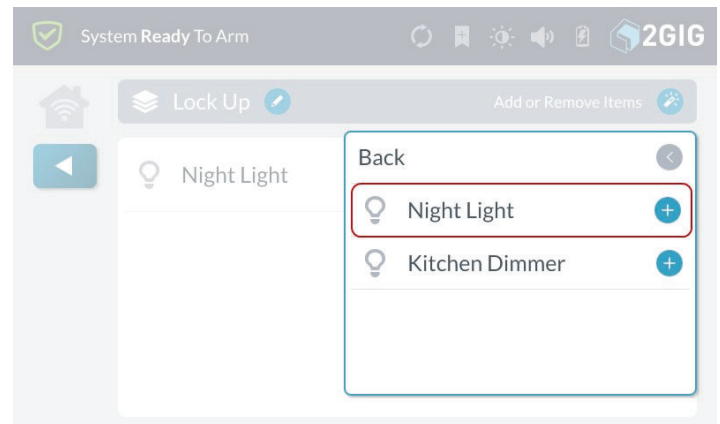

When the device is added to the scene, the icon changes to **YELLOW**.

*Add or Remove Items > Lights > Device Added*

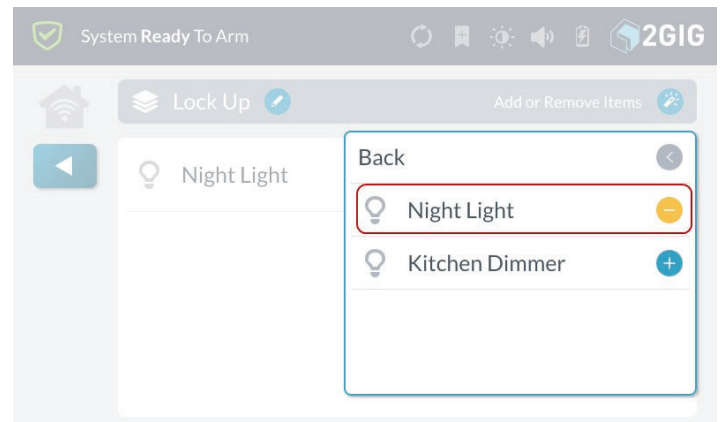

10. Choose one of these options:

- » To add other devices to the scene, tap **Back**.
- » To save the scene as is, tap any area outside of the drop-down menu to close it.

Any devices added to the scene appear in the list.

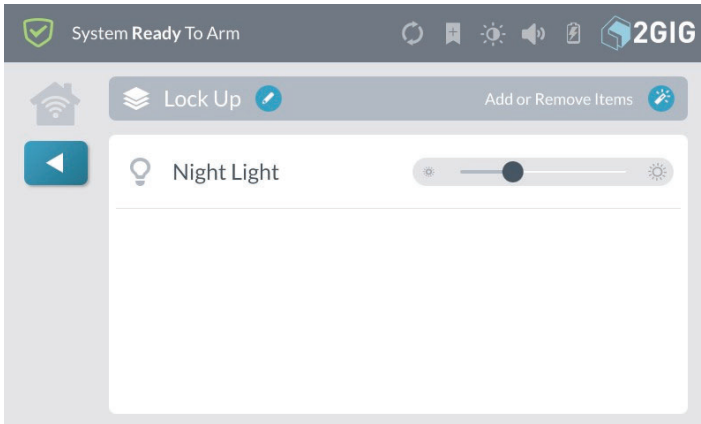



11. Set the desired settings for each device in the scene. When the scene is run, it will perform the chosen actions for all devices in the scene.
12. Tap  when finished.

### Execute a Scene

To execute a scene:

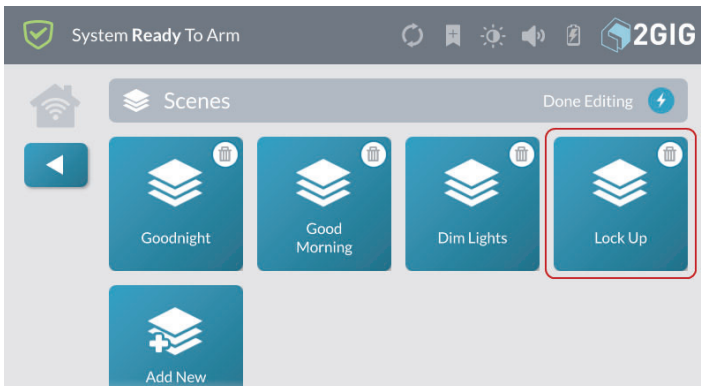
1. Navigate to the **Smart Home Controls** menu. See “Navigate to the Smart Home Controls Menu.”
2. At the Home screen, tap **Smart Home Controls**.
3. At the **Smart Home Controls** menu, tap **Scenes**.
4. Tap the button for the desired scene. For example, tap **Lock Up**.



5. When the **Scene <Name> was Executed** message appears, tap **OK** or wait a few seconds for the message to close automatically.
6. Tap  when finished.

### Deleting a Scene

To delete scene:

1. Navigate to the **Smart Home Controls** menu. See “Navigate to the Smart Home Controls Menu.”
2. At the **Smart Home Controls** menu, tap **Edit Scenes**.

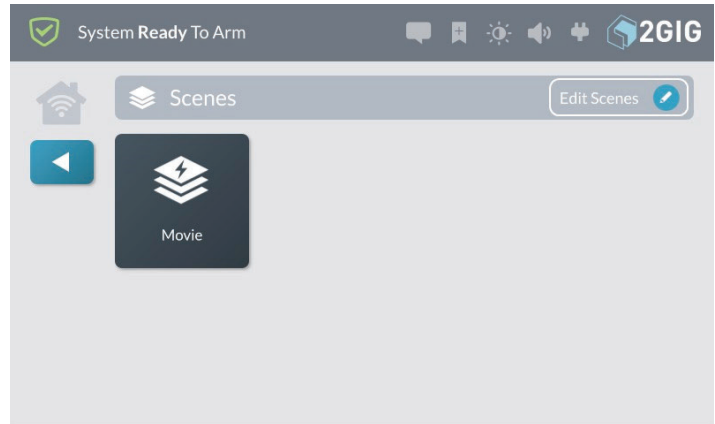

This places the **Scenes** screen into edit mode.

3. While the system is in editing mode, tap the trash can icon that corresponds to the scene to delete.

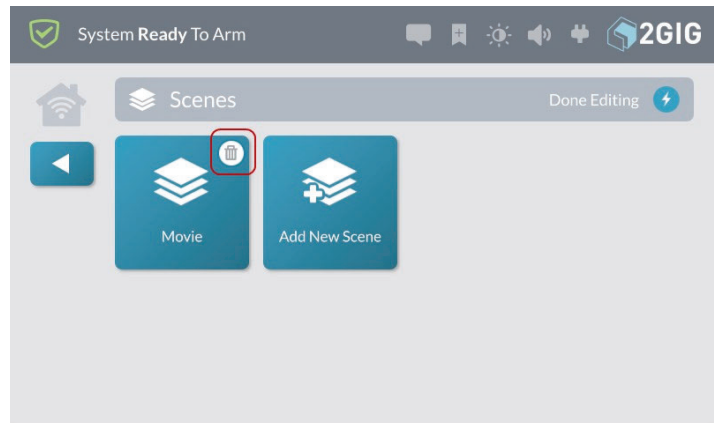

4. At the **Delete Scene <Name>** message, tap **Delete**.

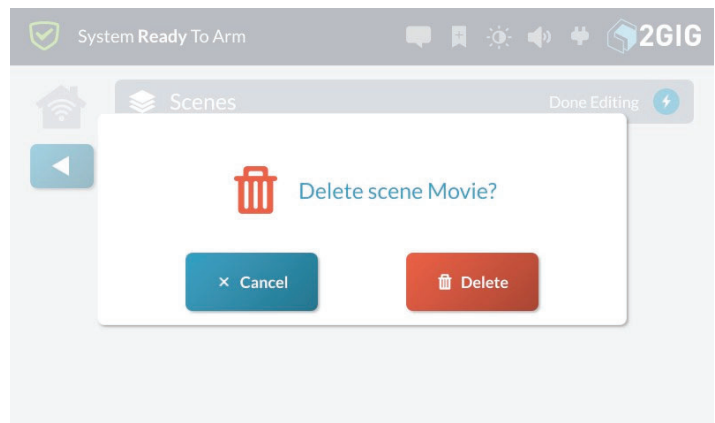

5. Tap  when finished.

## Add a New Room

Use the **Rooms** screen to create customized settings for the smart home controls in a specific room. There is no functional limit on the number of rooms that you can create for the system.

### Rooms Screen

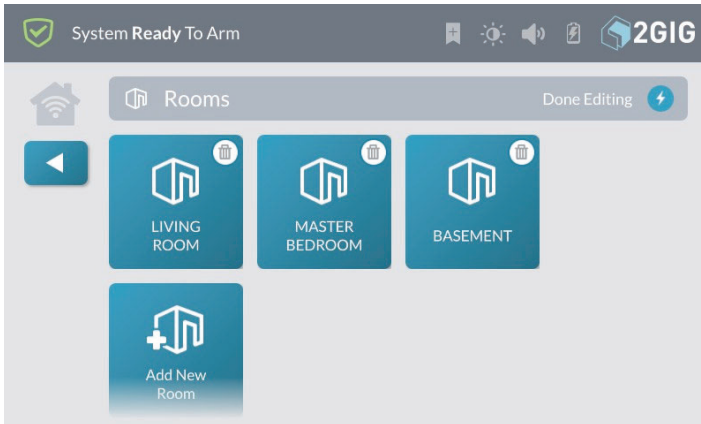

### Examples: When to Create Rooms

There are a wide variety of rooms that you can create. Some of the more common include:

- » **Front Room** Create customized settings for your dwelling's living room.
- » **Master Bedroom** Create customized settings for your dwelling's master bedroom.
- » **Basement** Create customized settings for your home's basement.

## Add a New Room

To add a new room:

1. Navigate to the Smart Home Controls menu. See "Navigate to the Smart Home Controls Menu."
2. At the **Smart Home Controls** screen, tap **Rooms**.

### Smart Home Controls > Rooms

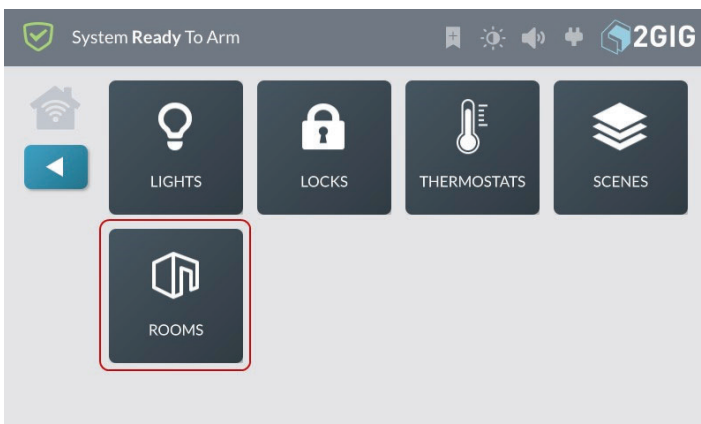

This reveals the **Rooms** screen.

3. At the **Rooms** screen, tap **Edit Rooms**.

### Rooms > Edit Rooms

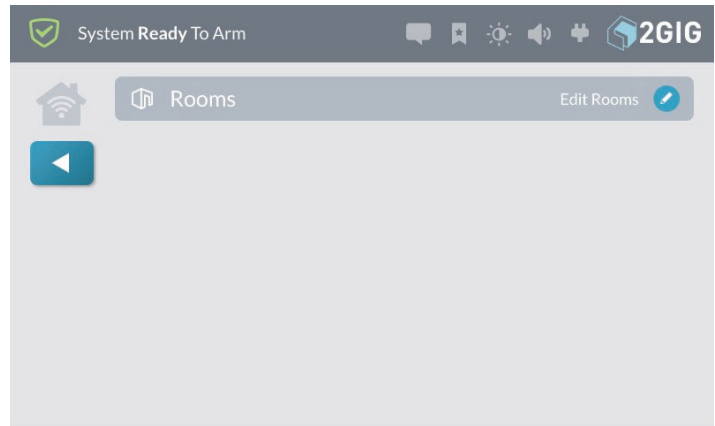

4. While in editing mode, tap **Add New Room**.

### Add New Room

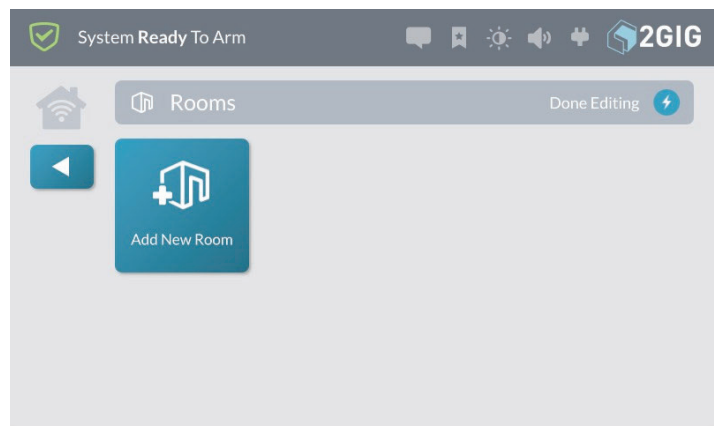

5. At the **Enter a Name for the New Room** screen, enter a name and then tap **Next**.

For example, enter: **Home Theater**

### Enter a Name for the New Room

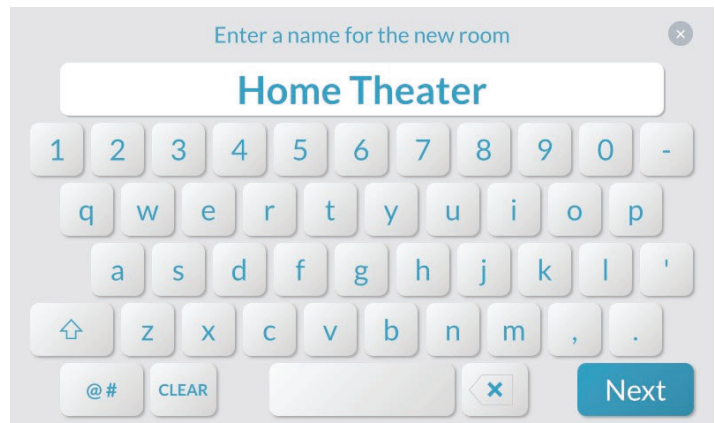

6. At the **<New Room Name>** screen, tap **Add** or **Remove Items**.

### Add or Remove Items

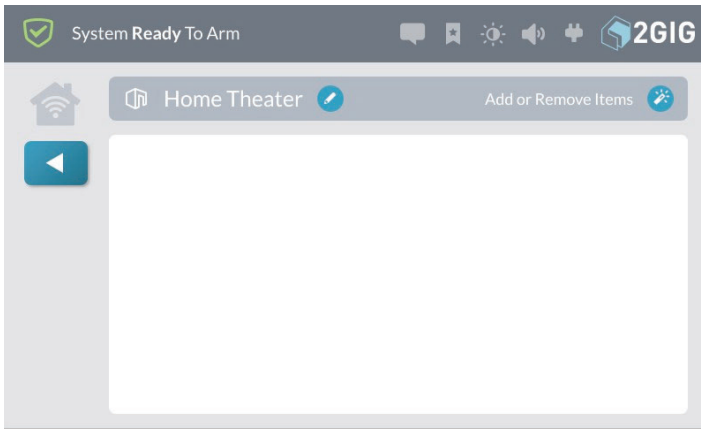

7. At the drop-down list, tap the type of device to add.  
For example, tap **Lights**.

### Add or Remove Items—Device Types

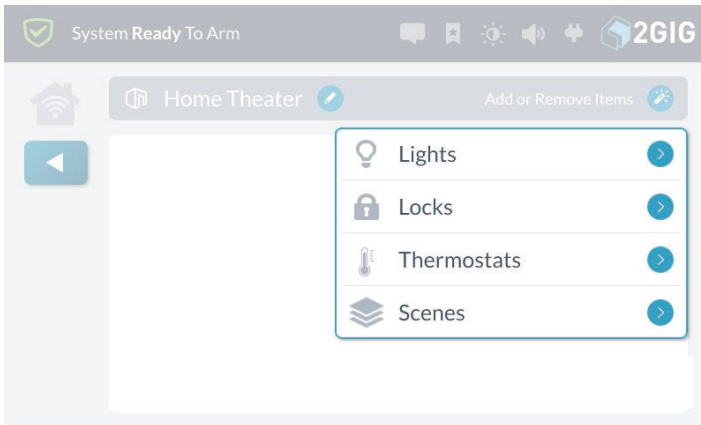

8. In the drop-down list, tap the device to add.

### Add or Remove Items—Add Device

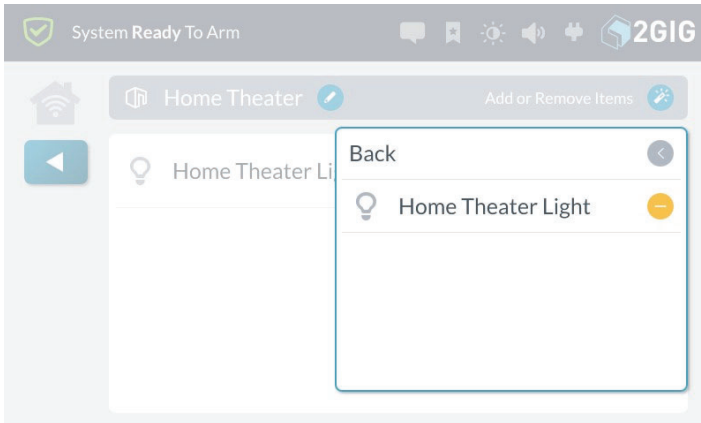

9. Choose one of these options:
  - » To add other devices to the room, tap **Back**.
  - » To save the room as is, tap any area outside of the drop-down menu to close it.

Any devices added to the room appear in the list.

### <Room Name>—Device Added

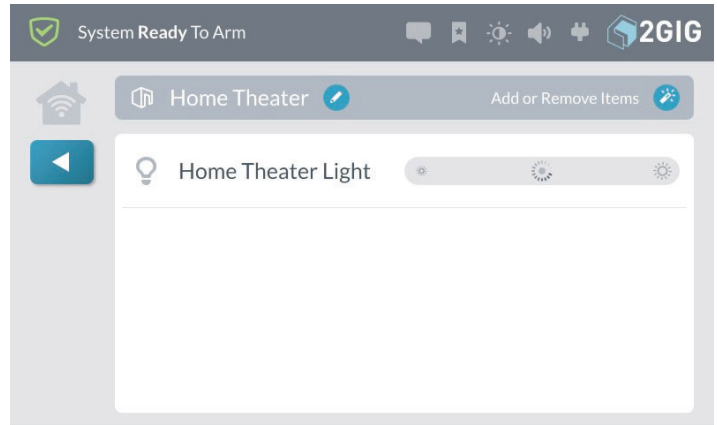

10. Tap  when finished.

## Access a Room

To access a room:

1. Navigate to the **Smart Home Controls** menu. See “Navigate to the Smart Home Controls Menu.”
2. At the Home screen, tap **Smart Home Controls**.
3. At the **Smart Home Controls** menu, tap **Rooms**.
4. Tap the button for the desired room.  
For example, tap **Living Room**.

### Rooms

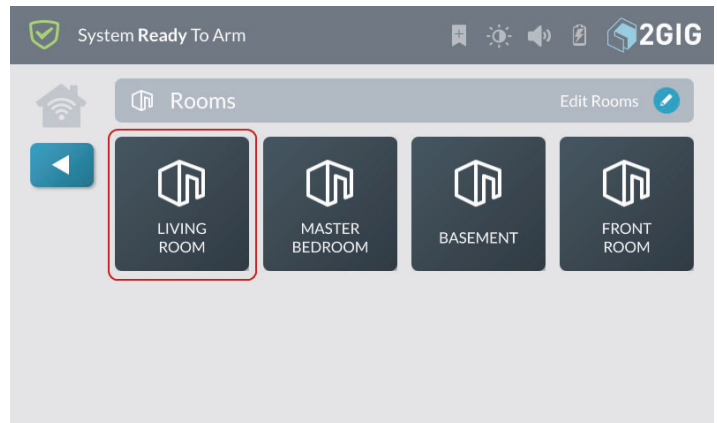

5. Tap  when finished.



## Deleting a Room

To delete room:

1. Navigate to the **Smart Home Controls** menu. See "Navigate to the Smart Home Controls Menu."
2. At the **Smart Home Controls** menu, tap **Edit Rooms**.

*Rooms > Edit Rooms*

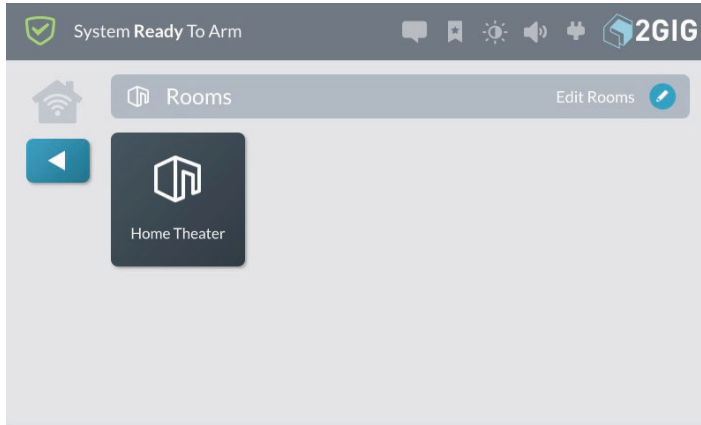

This places the **Rooms** screen into edit mode.

3. While the system is in editing mode, tap the trash can icon that corresponds to the room to delete.

*Room > Edit Rooms > Delete Room*

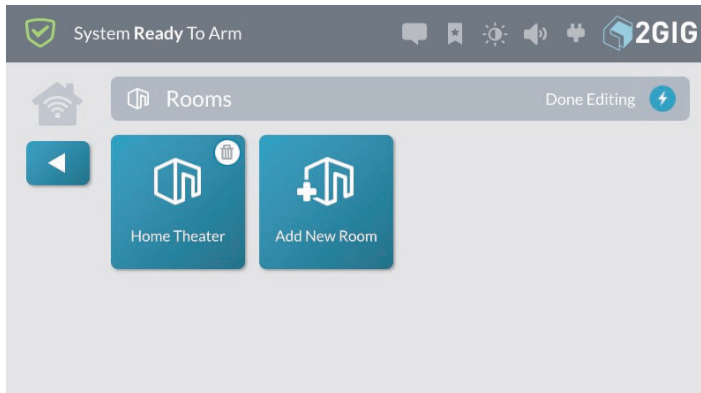

4. At the **Delete Room <Name>** message, tap **Delete**.

*Delete Room Name Message*

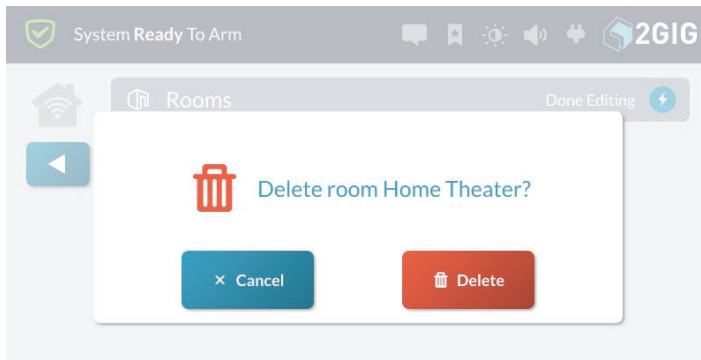

## Smart Areas

The System Areas Screen provides access to controls and status of all Smart Areas from the main panel or SP1 keypads.

The Smart Areas Button will change color to indicate status of the Smart Areas:

- » **Blue** - All Smart Areas are in a Normal State

*Smart Areas Button - Normal State*



- » **Yellow** - One or more Smart Areas are in a Trouble State.

*Smart Areas Button - Trouble State*

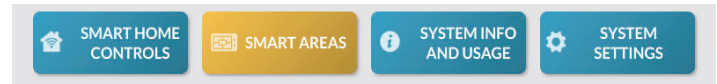

- » **Red** - One or more Smart Areas are in an Alarm State.

*Smart Areas Button - Alarm State*

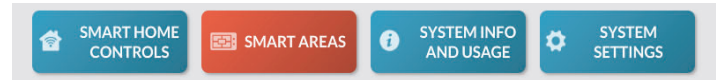

Press the **Smart Areas** button on the Home Screen

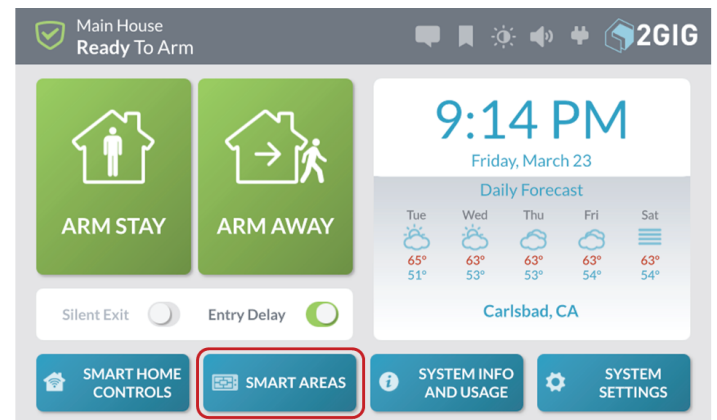

1. Enter user code – the user code controls access to the Smart Areas. After authentication, the Smart Areas Screen will only show the Smart Areas the user is assigned.

## Smart Areas - Enter Code



2. The Smart Areas Screen will display status for each Smart Area similar to the panel's home screen.

## Smart Areas - Rentals

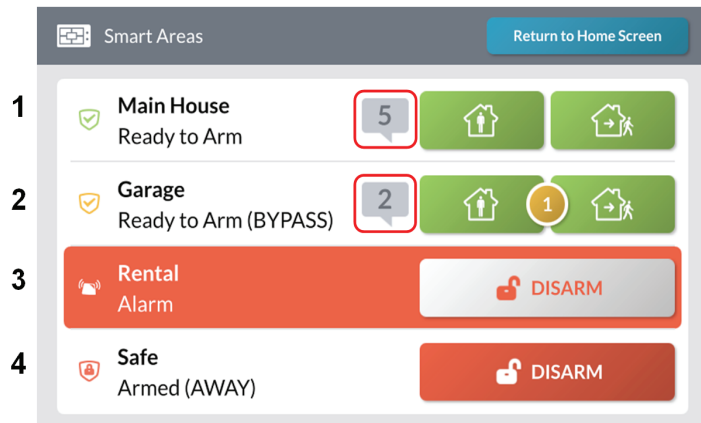

### Status Examples:

- 1: Ready to Arm
- 2: Ready with Bypassed zone
- 3: In Alarm
- 4: Armed Away

## Smart Areas – Notifications

The notifications icon will appear in a Smart Area if troubles or alarms exist.

1. Press the notification icon

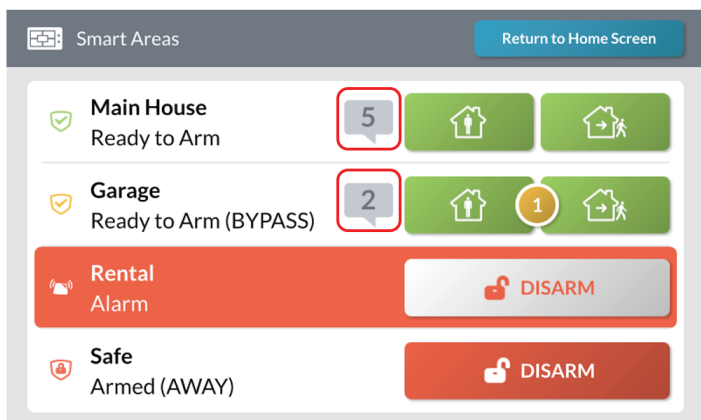

2. Press Alarm or Trouble

**NOTE:** This popup only appears if the Alarm and Alert conditions are present at the same time.

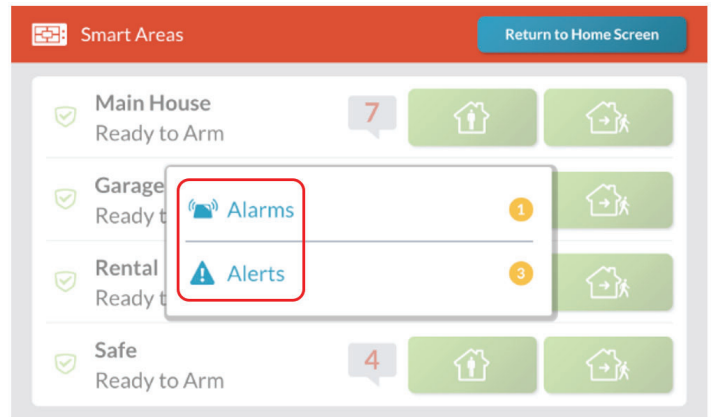

3. View Troubles – Press Acknowledge

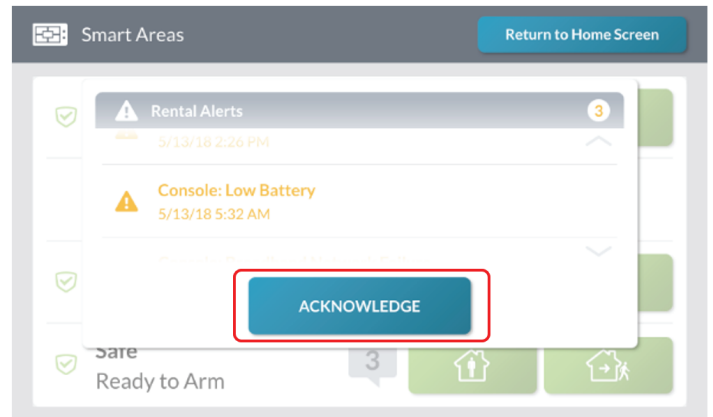

4. View Alarms – Press Acknowledge or Clear

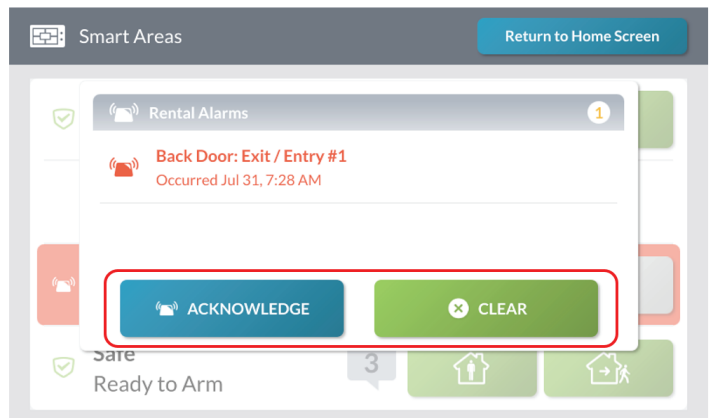

## Smart Areas - Arming

1. To Arm a Smart Area press the Arms Stay or Arm Away button/s.

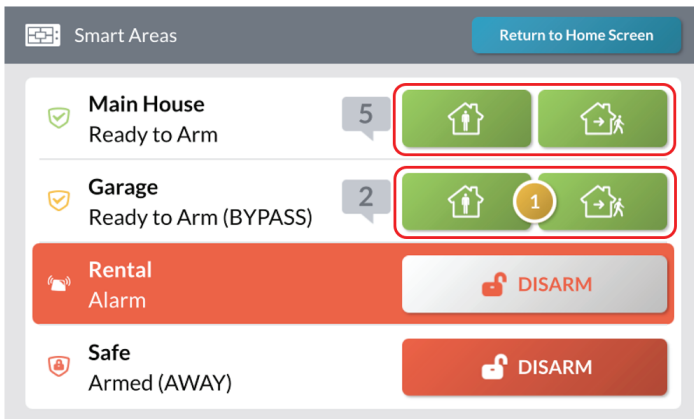

## Smart Areas - Alarms

1. To acknowledge or clear an alarm press the Disarm button on the Smart Area that is displaying an alarm.

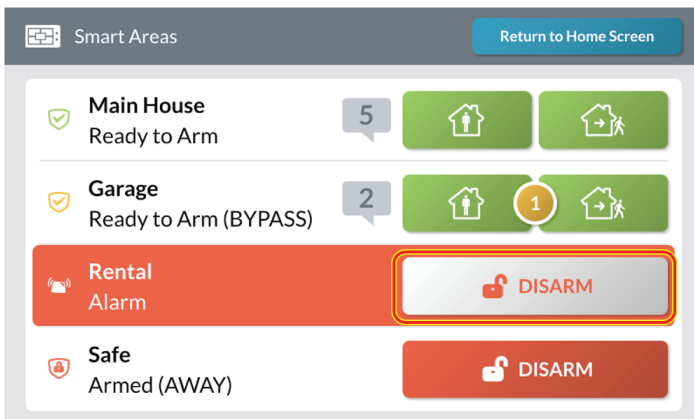

2. Press Acknowledge or Clear

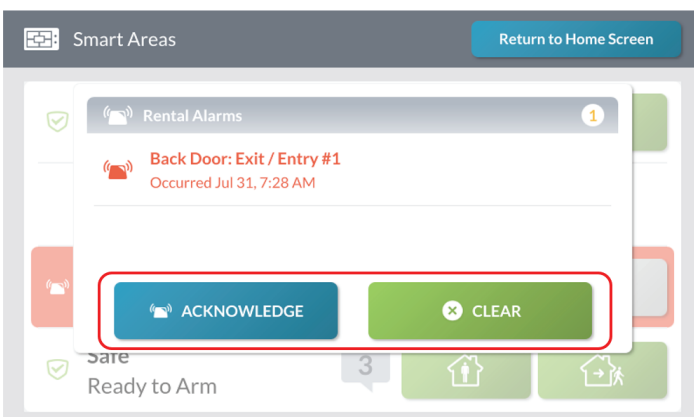

## Smart Areas - Disarm

1. To disarm a Smart Area press the Disarm button

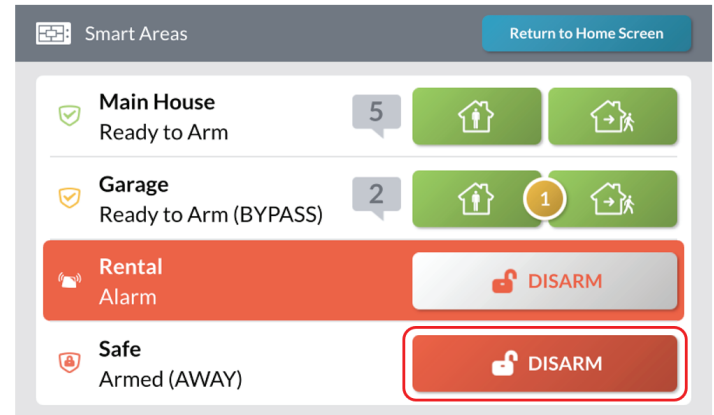

## System Info and Usage

The **System Info and Usage** menu provides access to the system's history, system information, and security provider's contact information.

*System Info and Usage Menu*

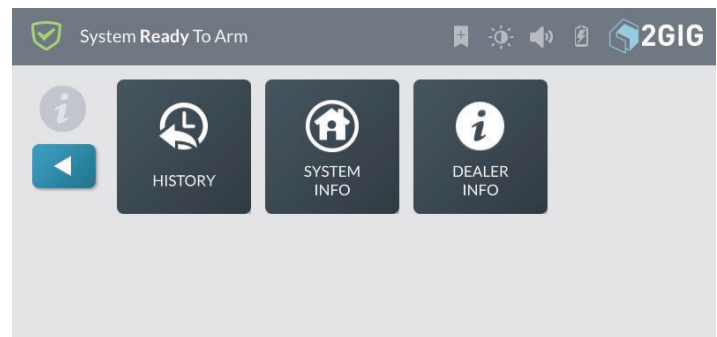

## History

The **History** screen shows a chronological log of system events. Each event is recorded with a date and time stamp:

- » **System Armed/Disarmed:** Keeps a record of when the system is armed and disarmed.
- » **Zone Bypassed/Unbypassed:** Keeps a record of when zone sensors are bypassed and unbypassed, and makes a note when zones are bypassed or unbypassed by the installer.
- » **Alarms Triggered/Cleared:** Keeps a record of when alarm conditions are triggered and cleared.
- » **Alerts:** Keeps a record of when the GC3 Panel or a zone issue an alert. For example, low battery, AC power loss, or tamper conditions.
- » **\*Programming Mode Started/Terminated:** Keeps a record of when the installer accesses and exits the Installer Toolbox.
- » **\*Walk Test Mode Started/Terminated:** Keeps a record of when the installer starts and stops a Sensors Test and Console Test.

**NOTE:** Events marked with an asterisk (\*) always appear in the log and cannot be filtered from view.

## Navigate to the History Screen

To navigate to the History screen:

1. At the Home screen, tap **System Info and Usage**.



2. At the **System Info and Usage** menu, tap **History**.

*System Info and Usage Menu*

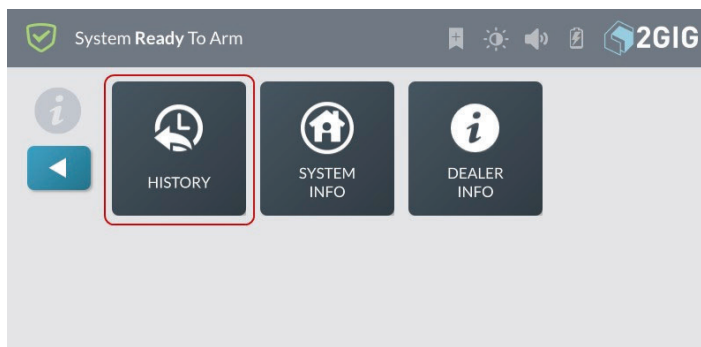

This reveals the **History** screen. See “Filtering the History Screen” below.

## Filtering the History Screen

You can filter the list in the **History** screen to show or hide alarms, bypasses, or alerts.

*History —Filter Check Boxes*

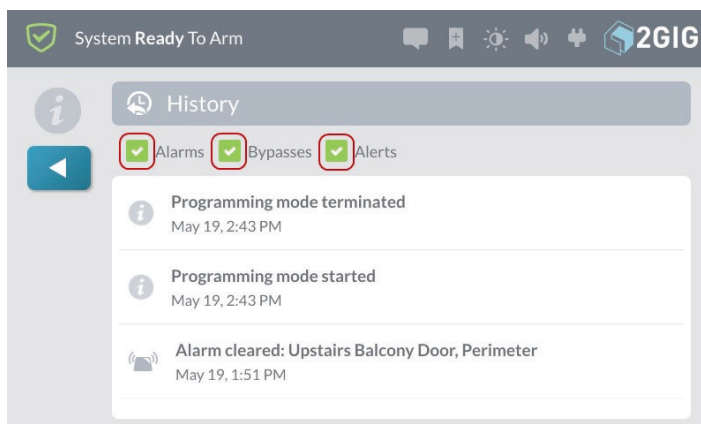

At the **History** screen, tap one of these check boxes to add or remove the check mark:

- » **Alarms:** Add a check mark to show alarm events. Remove the check mark to hide alarm events.

- » **Bypasses:** Add a check mark to show bypasses. Remove the check mark to hide bypasses.
- » **Alerts:** Add a check mark to show alerts. Remove the check mark to hide alerts.

## System Info

The **System History** screen shows the following information about your GC3 Panel (depending on the features that are active in your system):

- » Z-Wave Home ID
- » Serial Number
- » Firmware Version
- » Build Version
- » Radio Modem
- » Z-Wave Version
- » Open Source Licenses Information

## Navigate to the System Info Screen

To navigate to the System Info screen:

1. At the Home screen, tap **System Info and Usage**.

*Home screen > System Info and Usage Button*

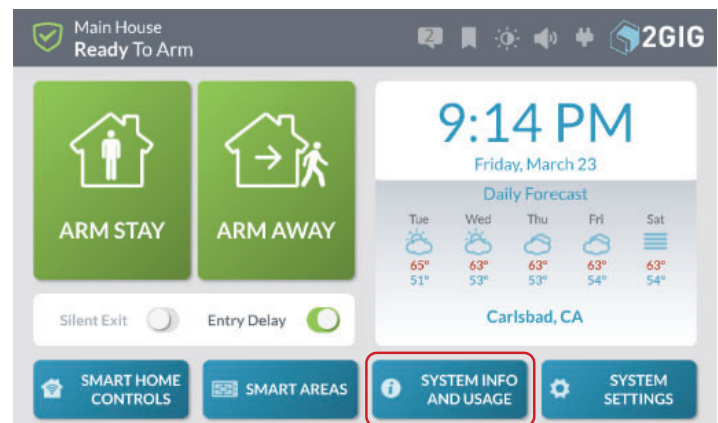

2. At the **System Info and Usage** menu, tap **System Info**.

*System Info and Usage Menu*

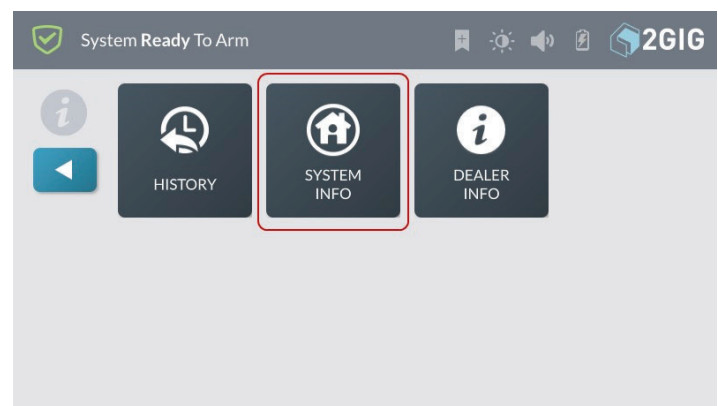

This reveals the **System Info** screen.

### System Info Screen

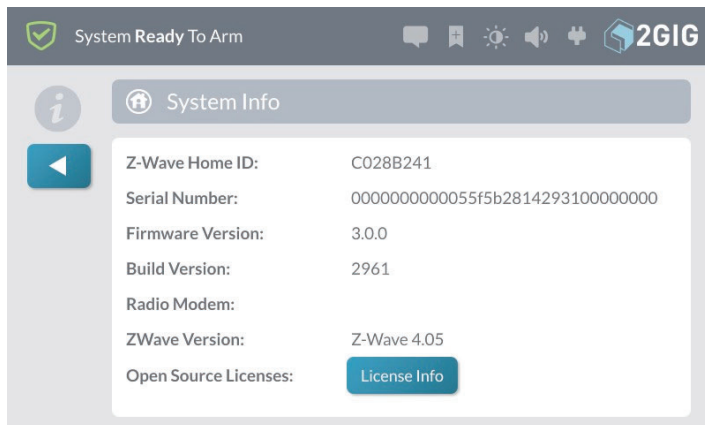

### Dealer Info

The **Dealer Info** screen shows basic contact information for your 2GIG alarm dealer.

### Navigate to the Dealer Info Screen

To navigate to the **Dealer Info** screen:

1. At the Home screen, tap the **System Info and Usage** button.

### System Info and Usage Button

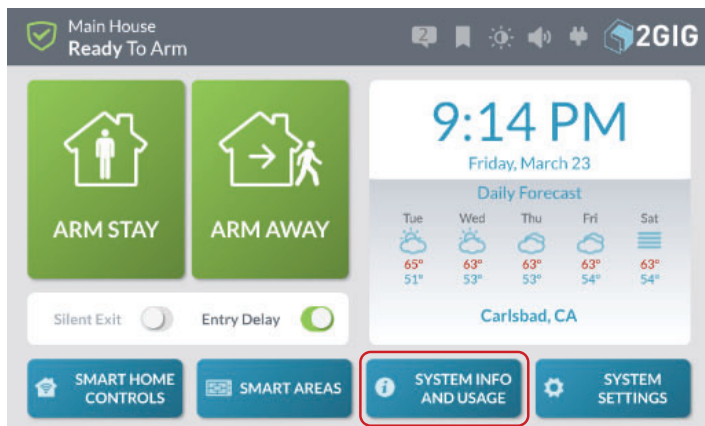

2. At the **System Info and Usage** menu, tap **Dealer Info**.

### System Info and Usage Menu

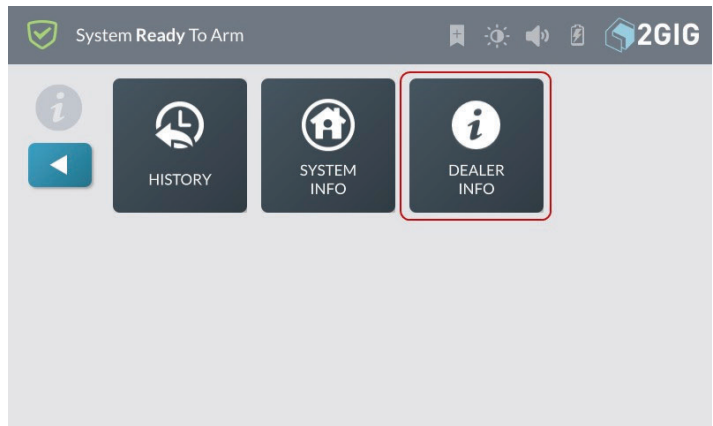

This reveals the **Dealer Info** screen. See “About the Dealer Info Screen” in the next section.

### About the Dealer Info Screen

For information about your 2GIG alarm dealer, navigate to the **Dealer Info** screen. See “Navigate to the Dealer Info Screen” above.

### Dealer Info Screen

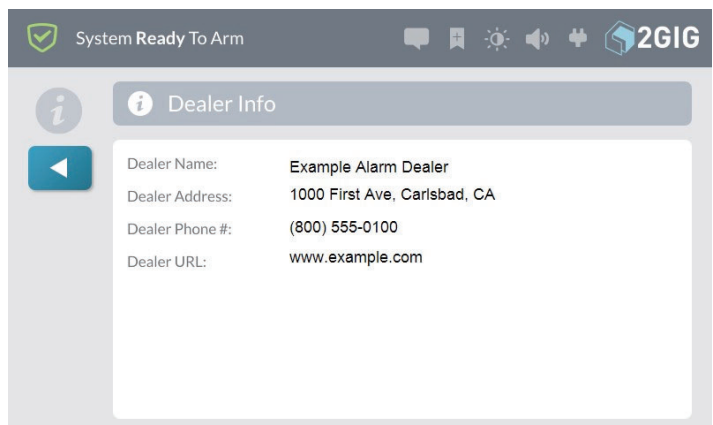

This screen provides you with the following information:

- » **Dealer Name:** Reveals the company name for your 2GIG alarm dealer.
- » **Dealer Address:** Reveals the mailing address for your 2GIG alarm dealer.
- » **Dealer Phone #:** Reveals your 2GIG alarm dealer’s telephone number.
- » **Dealer URL:** Reveals the web site url for your 2GIG alarm dealer.

# System Settings

## Users

The Users menu lets you add, edit, and delete users from the system.

**NOTE:** To use this feature, you must know the four-digit Master User Code.

## Types of User Codes

There are different types of user codes to provide users with access to various system features:

**IMPORTANT:** Do Not Share Your User Codes.

Operators at the Central Station may need to review the codes used to determine your identity. The codes entered may need to be used as a decision-making tool for dispatching emergency assistance.

- » **User Code:** A unique, four-digit code to identify different system users and provide them with the ability to disarm the system.
- » **Master User Code:** A four-digit code typically known by one or two members of a household. The default code is **1111**. To secure this code, it is recommended that you immediately change the default code to a unique one.
- » **Duress Code:** A four-digit code that you enter to silently notify your Remote Service Provider of an emergency event, such as being forcibly held against your will by an intruder.
- » **Installer Code:** A four-digit code that provides professional installer's and 2GIG alarm dealers with access to the system's programming functions.

## Activating the Duress Code

The system supports a total of 100 four-digit pass codes (this includes both the Master User Code and the Duress Code). Although the Duress Code is listed by default on the Users screen, it is not activated by default.

To activate the Duress Code:

1. At the **Home** page, tap **System Settings**.
2. Enter the Master User Code to access the **System Settings** menu.
3. At the **System Settings** menu, tap **Users**.

### System Settings > Users

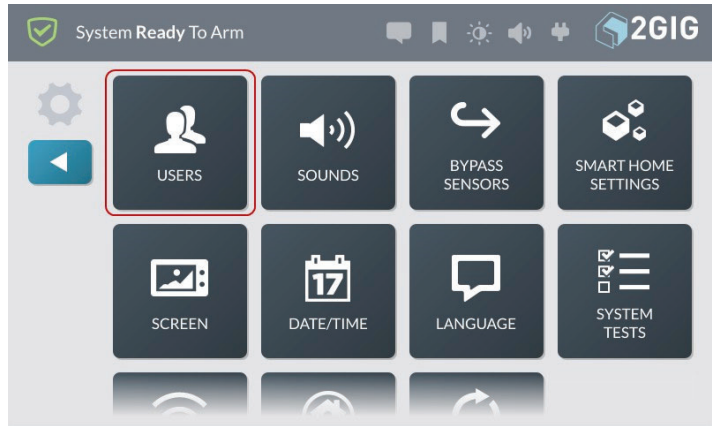

4. This reveals the **Users** screen. If this is the first time you are adding a user, you will notice that two (2) users have already been created: the **Master User** (which is active) and the **Duress** user (which is grayed out).

### Users Screen

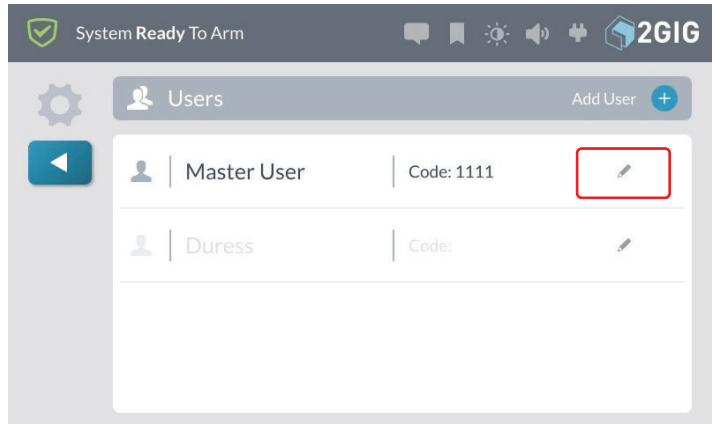

5. Tap the pencil icon next to the **Duress** user.

### Users Screen > Edit Duress User

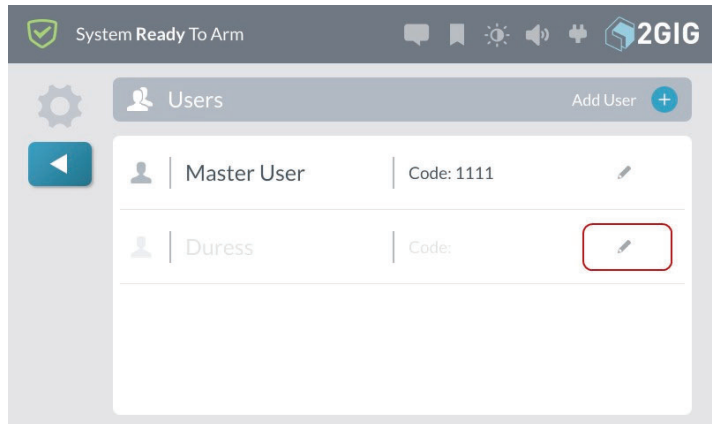

6. At the **Edit Duress User** screen, tap the **Active** button in the top row.

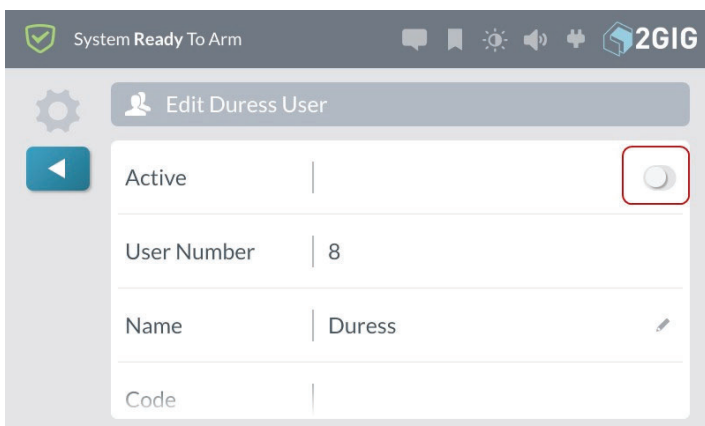

- At the **Enter a code for user Duress** screen, enter a unique four-digit code for the duress user and tap **Next**.

*Distress User Code*

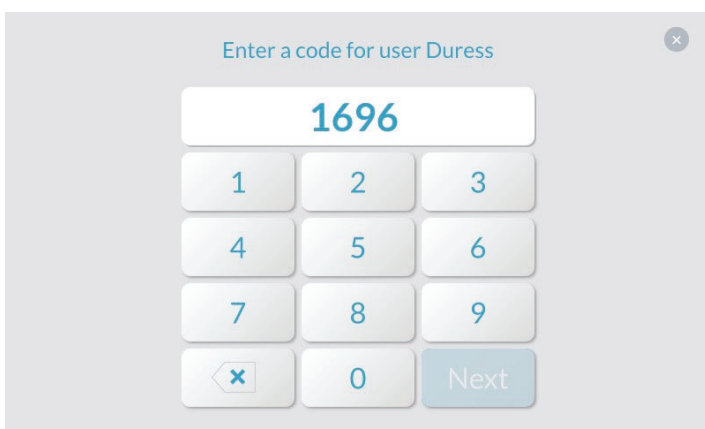

- At the **Confirm code for user Duress**, enter the code again and tap **Done**.

*Edit Duress User Screen*

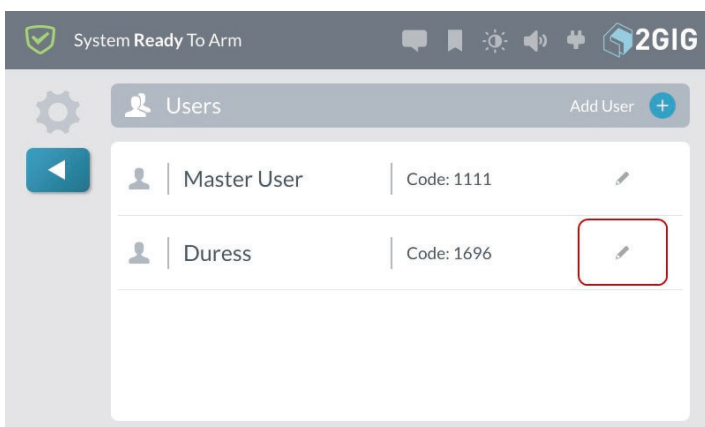

- Tap  when finished.

## Adding a User

You can add new users to the system. The system supports a total of 100 four-digit pass codes (this includes both the Master User Code and Duress Code).

To add a user:

- At the **Home** screen, tap **System Settings**.
- Enter the Master User Code to access the **System Settings** menu.
- At the **System Settings** menu, tap **Users**.  
This reveals the **Users** screen. If this is the first time you are adding a user, you will notice that two (2) users have already been created. The **Master User** and the **Duress** user.
- Tap **Add User**.

*Users Screen > Add User*

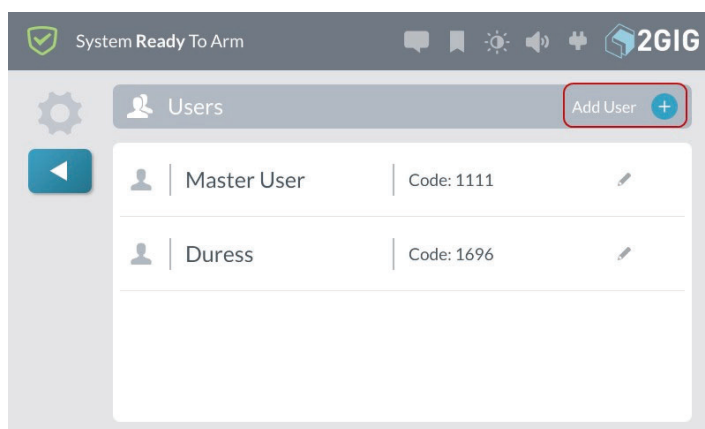

- At the **Enter a Name for the New User** screen, enter a name for the new user. Then tap **Next**.

*Enter New User Name*

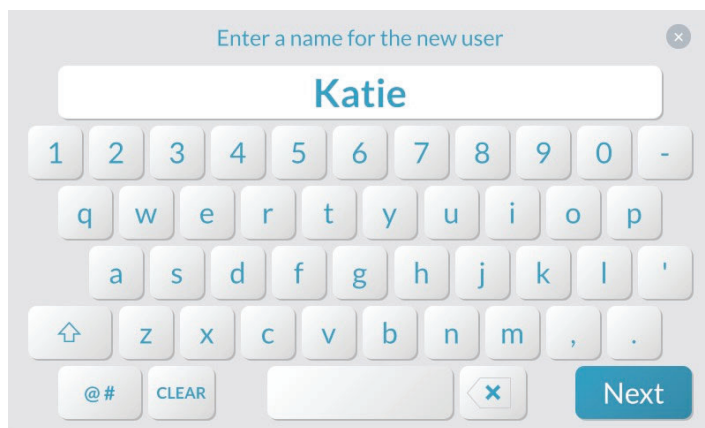

- At the **Enter a code for User <Name>** screen, enter a unique four-digit code for the new user. Then tap **Next**.

**NOTE:** If you attempt to add a code that is already in use, the system prompts you to enter a different

code. Every user code must be unique.

Enter a User Code

7. At the **Confirm code for user <Name>** screen, re-enter the four-digit code for the new user. Then tap **Next**.

Confirm code for user <Name>

The new user name and code appears in the **Users** page.

User Screen > New User

8. Tap  when finished or continue with the steps in "Editing a User" below

## Editing a User

To edit a user:

1. At the Home screen, tap **System Settings**.
2. Enter your four-digit user code to access the **System Settings** menu.
3. Tap **Users**.
4. Tap the pencil icon next to the desired user.

User Screen > Edit User

5. Make the desired changes on the **Edit User** page. See "Editing Options" in the next section.

Edit User Screen

6. Tap  when finished.



## Editing Options

When editing a user, you have these options:

### Change the User Status to Active or Inactive

To change the user status to active or inactive:

1. Open the **Edit User** page. See “Editing a User” above.
2. If you want to make the user profile inactive, move the **Active** slide control to the left.

*Edit User Screen > Inactive Status*

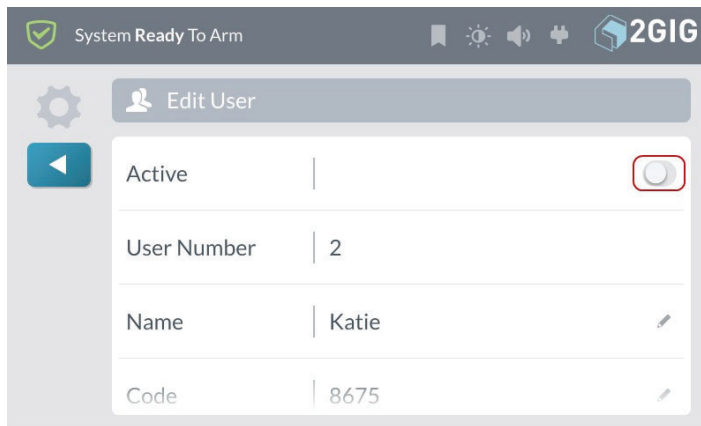

3. If you want to make the user profile active, move the slide control to the right. This is the factory default setting.

*Edit User Screen > Active Status*

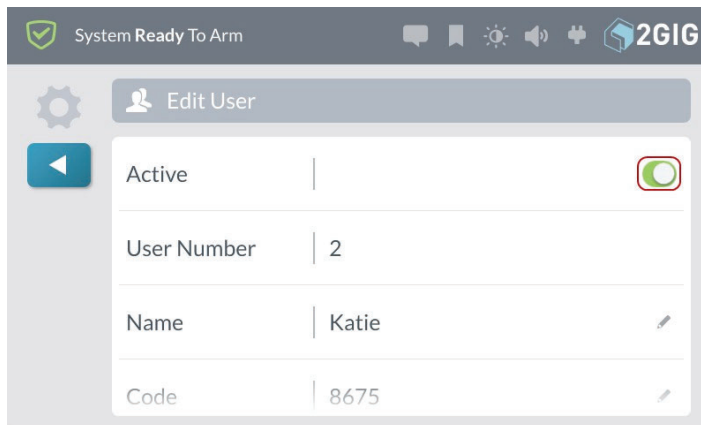

### Change a User Name

To change a user name:

1. Open the **Edit User** page. See “Editing a User” above.
2. Tap the pencil icon next to the user name.

*Edit User Screen > Edit Name*

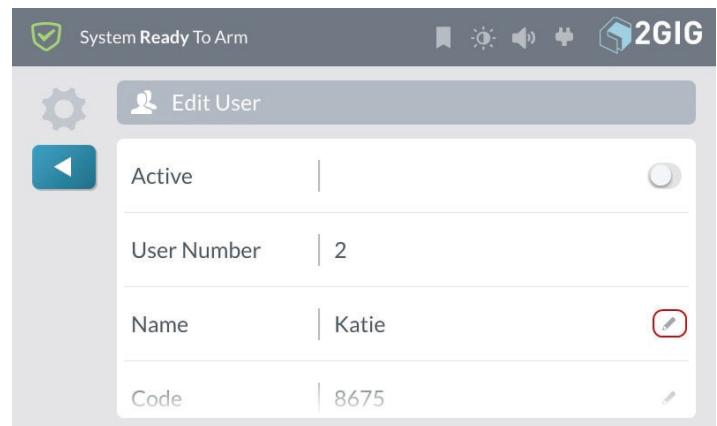

3. At the **Enter a name for the user** screen, enter a new user name.

*Enter User Name*



4. Tap **Done**.

### Change a User Code

To change a user code:

1. Open the **Edit User** page. See “Editing a User” on the previous page.
2. Tap the pencil icon next to the user code.

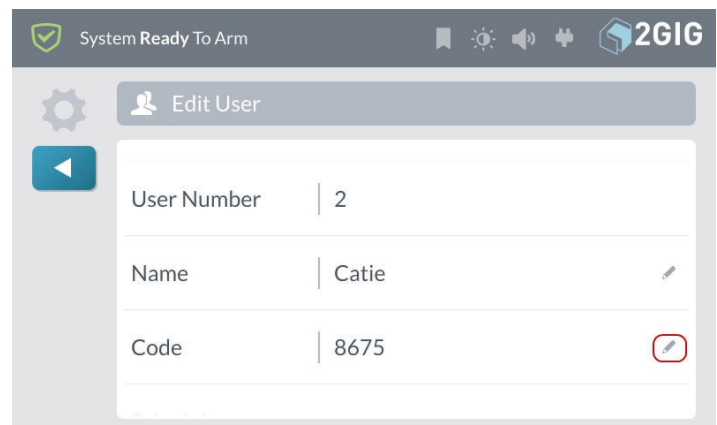

- At the **Enter a Code for User** screen, enter a unique four-digit code for the user. Then tap **Next**.

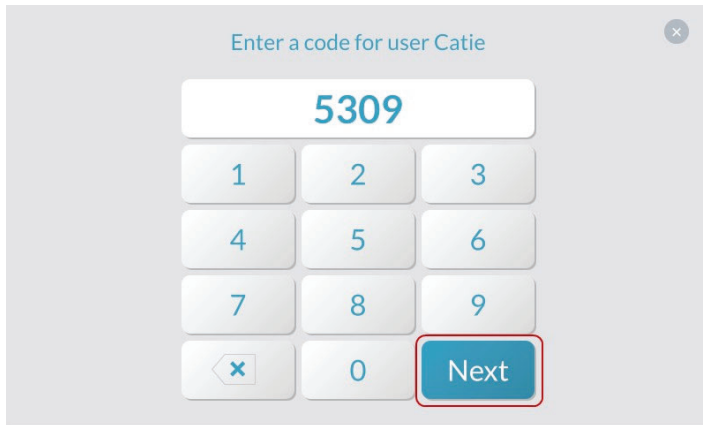

- Enter the code again to confirm it.

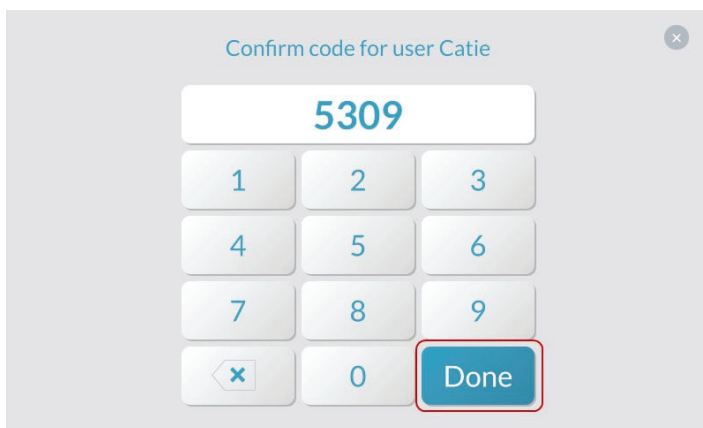

Tap **Done**. Adding a User Schedule

### Adding Smart Area Assignment

To add Smart Area assignment for a user:

- Open the **Edit User** page. See “Editing a User” on the previous page.
- Scroll down to **Smart Areas**.
- Tap to place a checkmark next to the **Smart Area**.
  - A checkmark allows the user to control that Smart Area
  - No checkmark – user has no access to the SmartArea.

### Add Smart Area

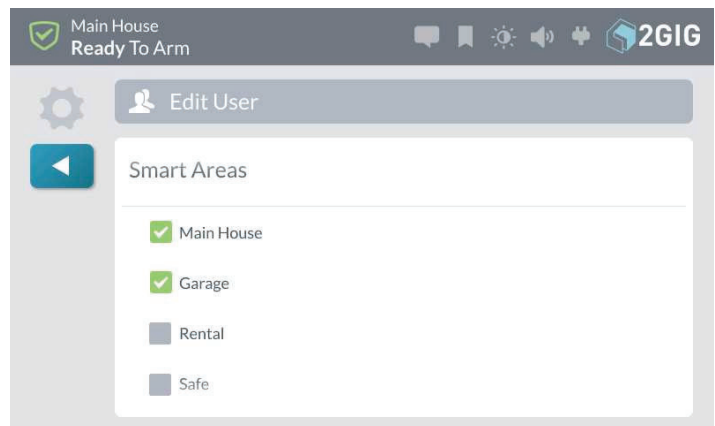

### Adding a User Schedule

To add a schedule:

- Open the **Edit User** page. See “Editing a User” on the previous page.
- Scroll down to **Schedules**.
- Tap **Add Schedule**.

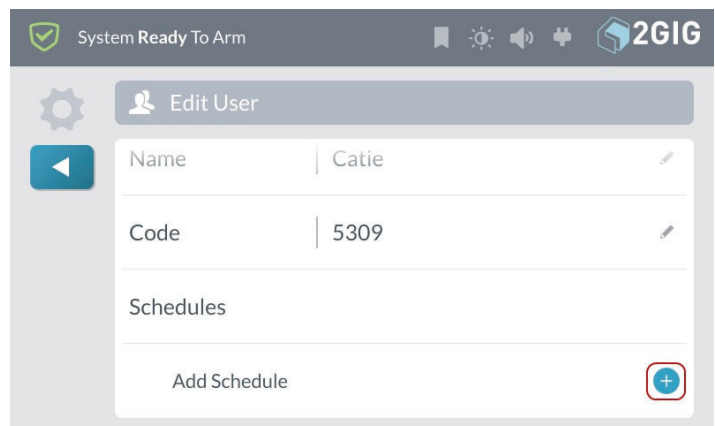

- Choose one of these options:

#### Adding a Recurring Schedule

If a user requires access to your dwelling on a recurring schedule, you can create a schedule for that user. For example, a housekeeper or tutor might need recurring access to your home on certain days of the week.

To add a recurring schedule:

- Tap **Recurring**.
- Place a check mark in the desired day of week boxes. For example, place a check mark in the Mon, Wed, and Fri boxes.
- Tap **Set Start Time**. Scroll to the desired **Hour**, **Minute**, and **AM/PM** and tap **Set**.
- Tap **Set End Time**. Scroll to the desired **Hour**, **Minute**, and **AM/PM** and tap **Set**.

## Create a Schedule

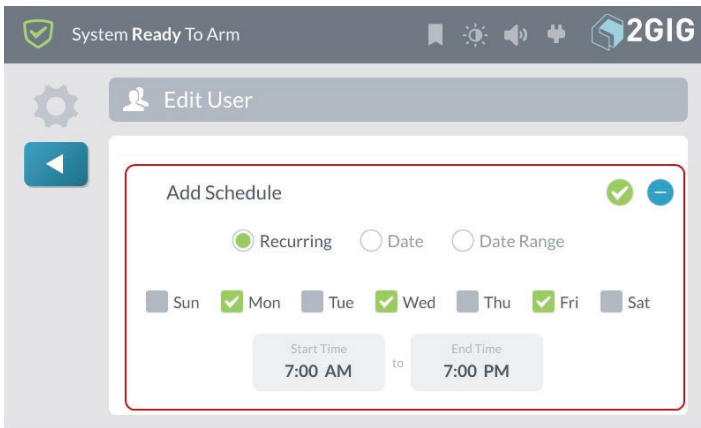

e. Tap  to save the schedule.

**Note:** A schedule assigned to a user applies to all Smart Areas. Schedules cannot be assigned to individual Smart Areas.

### Adding a Date Schedule

If a user requires access to your dwelling on a specific date, you can create a schedule for them. For example, a repairman might need access to your home on a single date.

To add a date schedule:

- Tap **Date**.
- Tap **Set Date**. Scroll to the desired **Month**, **Day**, and **Year** and tap **Set**.
- Tap **Set Start Time**. Scroll to the desired **Hour**, **Minute**, and **AM/PM** and tap **Set**.
- Tap **Set End Time**. Scroll to the desired **Hour**, **Minute**, and **AM/PM** and tap **Set**.

### *Add Date Schedule*

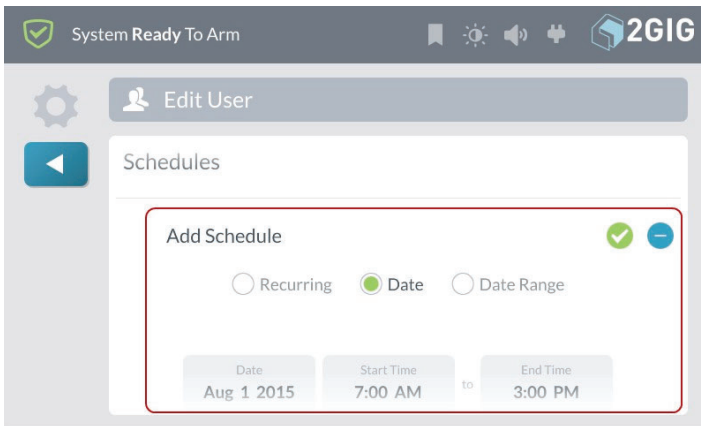

e. Tap  to save the schedule.

### Adding a Date Range Schedule

If a user has a need to access your dwelling for a period of time, you can create a schedule for them. For example, a visitor in your home who needs access for a few weeks.

To add a date range schedule:

- Tap **Date Range**.
- Tap **Set Start Date**. Scroll to the desired **Month**, **Day**, and **Year** and tap **Set**.
- Tap **Set End Date**. Scroll to the desired **Month**, **Day**, and **Year** and tap **Set**.
- Tap **Set Start Time**. Scroll to the desired **Hour**, **Minute**, and **AM/PM** and tap **Set**.
- Tap **Set End Time**. Scroll to the desired **Hour**, **Minute**, and **AM/PM** and tap **Set**.

### *Add a Date Range Schedule*

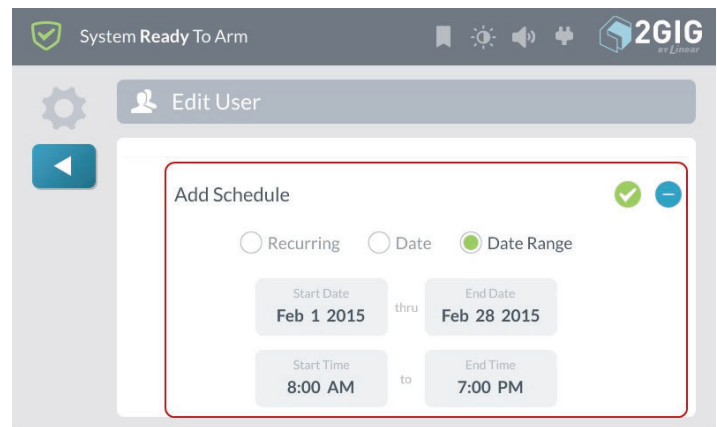

f. Tap  to save the schedule.

### Delete a User

If an occupant of your dwelling moves away and no longer needs access to your home, you can delete the user's profile.

**NOTE:** If you have shared the Master User Code or Duress Code with the user, it is also recommended that you change those codes.

To delete a user:

- At the Home screen, tap **System Settings**.
- Enter your user code to access the **System Settings** menu.
- Tap **Users**.

4. Tap the garbage can icon next to the desired user.

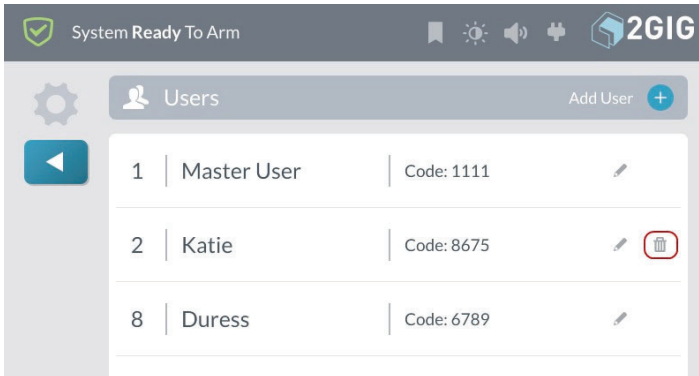

5. At the **Delete user** screen, tap **Delete**.

## Sounds

The **Sounds** menu lets you adjust the volume of the voice, chime, doorbells, keypad tones, and system annunciations.

### Adjust the Volume

To adjust the volume of a sound feature:

1. At the **Home** screen, tap **System Settings**.

*Home Screen > System Settings*

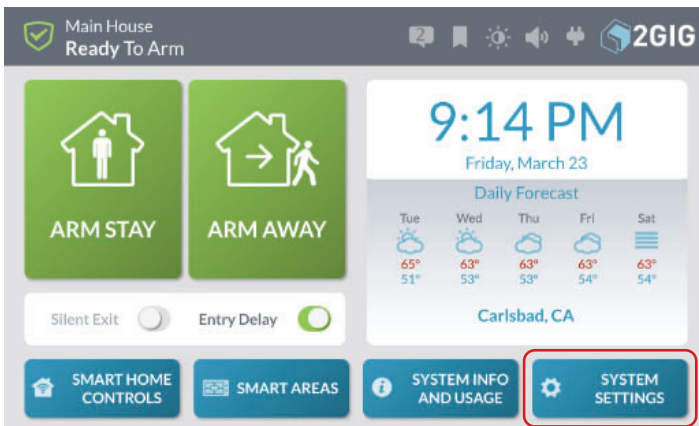

**NOTE:** To use this feature, you must know the four-digit Master User Code.

2. At the **Enter Your Code to Access the System Settings** screen, enter the four-digit Master User Code.

3. *Enter Your Code to Access the System Settings*

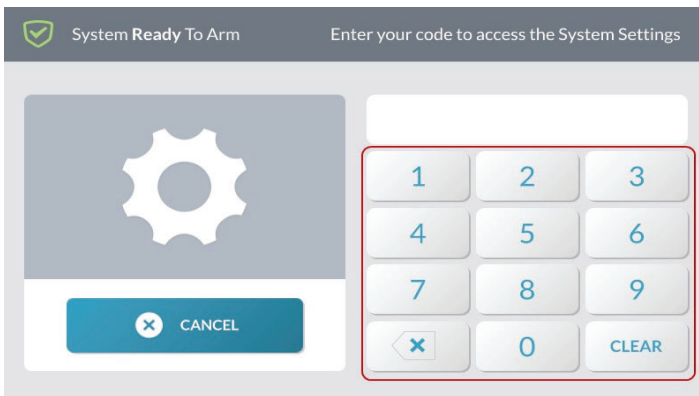

4. At the **System Settings** menu, tap **Sounds**.

*System Settings > Sounds*

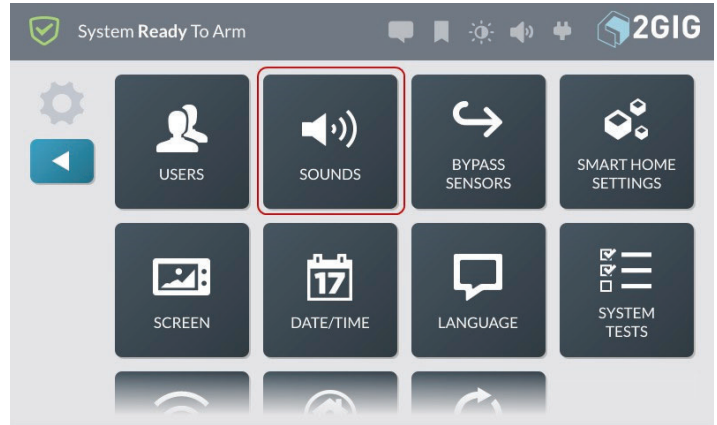

This reveals the **Sounds** screen.

*Sounds Screen*

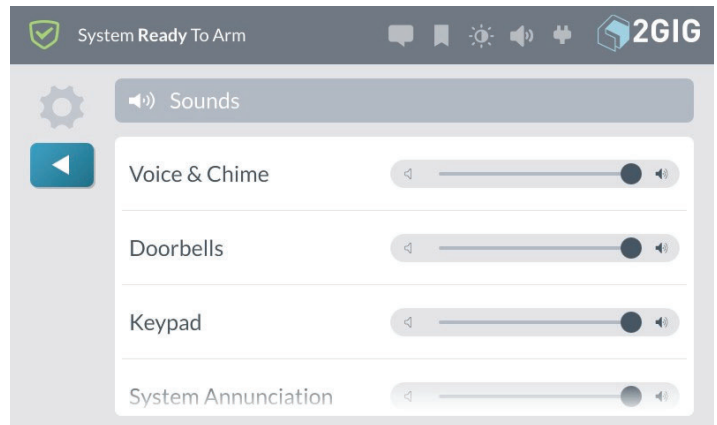

5. Swipe up or down to move the desired sound control into view.

6. Touch and hold the desired control and then swipe to the left to lower the volume or swipe to the right to raise the volume:

- » **Voice & Chime**
- » **Doorbells**
- » **Keypad**
- » **System Annunciation**

6. Tap  when finished.

## Bypass Sensors

You can manually bypass a sensor using the **Bypass Sensors** button in the **System Settings** menu. When you need to bypass one or more perimeter or interior sensors, it is most common to manually bypass the sensor. There is also an alternate method for bypassing a sensor called *Force Bypassing*. See “Force Bypassing.”

**NOTE:** To use this feature, you must know the four-digit Master User Code.

### Manually Bypassing a Sensor

When manually bypassing a sensor, tap the **Bypass Sensors** option in the **System Settings** menu to add the desired sensors to the **Bypassed Sensors** list.

**WARNING!!** A bypassed burglary protection sensor does NOT provide security protection when the system is armed. See “Force Bypassing.”

1. At the Home screen, tap **System Settings**.

*Home Screen—System Settings Button*

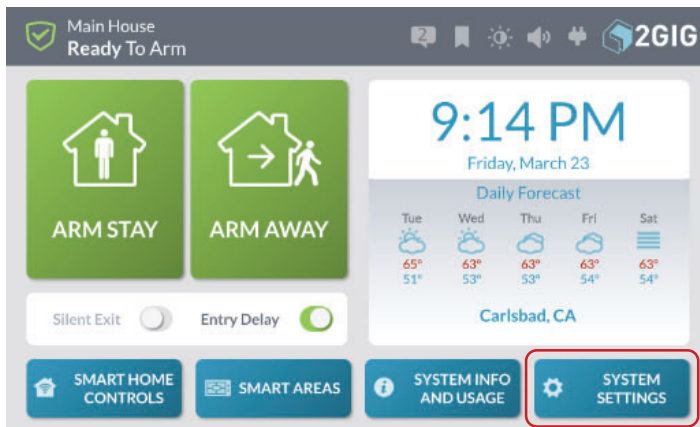

2. At the Enter Your Code to Access the **System Settings** screen, enter an active, four-digit user code.

*Enter Your Code to Access the System Settings*

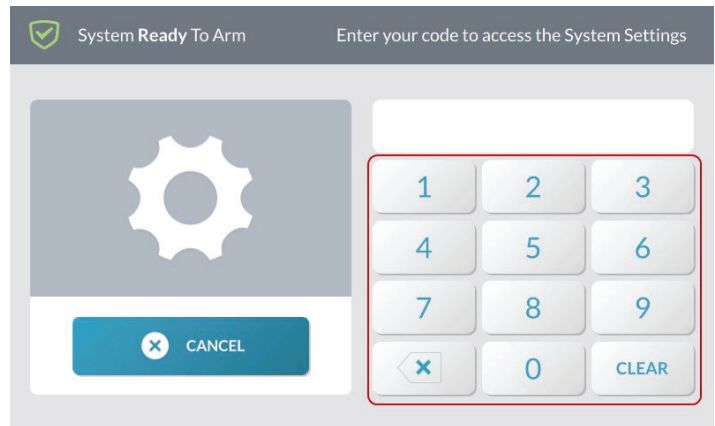

3. At the **System Settings** menu, tap **Bypass Sensors**.

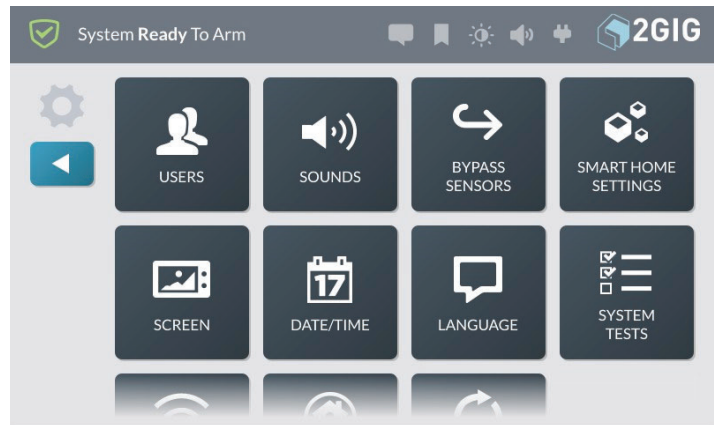

*System Settings > Bypass Sensors*

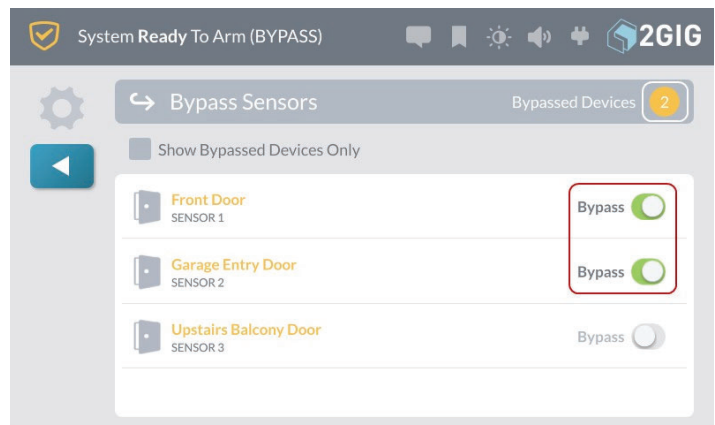

4. On the desired slide control, swipe right to add the sensor to the system's list of **Bypassed Devices**.

*Bypassed Sensors Screen*



5. Tap  to return to the **System Settings** menu.
6. Tap  to return to the **Home** screen.

The system bypasses the devices and its status changes to *System Ready To Arm (BYPASS)*.

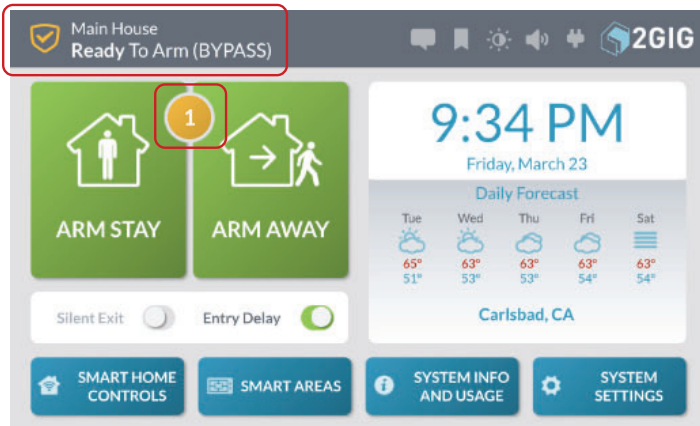

- Continue by arming the system. See “Arm the System.”

After the system is disarmed, bypassed sensors are automatically removed from the system’s **Bypassed Sensors** list, unless the **Auto Bypass for Manual Bypass** feature is enabled.

**NOTE:** Consult your installer to determine if the Auto Bypass for Manual Bypass feature is enabled. See the *GC3 Installation & Programming Guide*.

### Removing Sensors from the Bypassed Sensors List

After the system is disarmed, bypassed sensors are automatically removed from the system’s **Bypassed Sensors** list, unless the **Auto Bypass for Manual Bypass** feature is enabled. If you decide you want to remove a sensor from the **Bypassed Sensors** list before you arm the system, use the steps detailed here.

To remove a sensor from the **Bypassed Sensors** list:

- At the Home screen, tap **System Settings**.
- Enter the Master User Code to access the **System Settings**.
- Tap **Bypass Sensors**.
- Move the slide control to the left for the desired sensor. This removes the sensor from the system’s **Bypass Sensors** list.

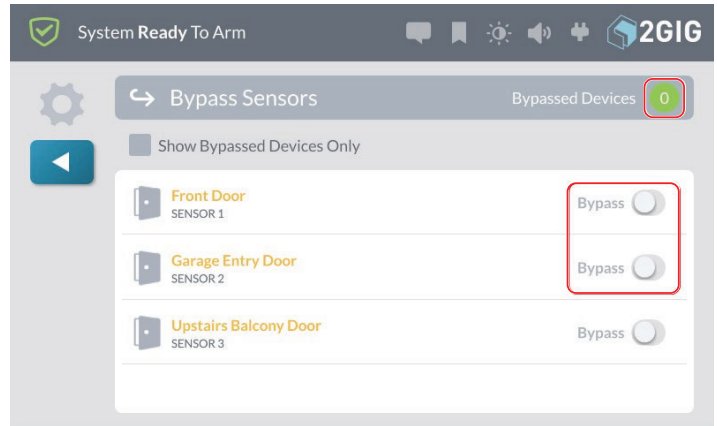

- Tap  when finished.

## Smart Home Settings Menu.

The **Smart Home Settings** menu provides installers with access to a variety of Z-Wave settings for the GC3 Security & Automation System.

Installers can configure the system to give the Master User permission to access the **Smart Home Settings** menu, users who know the Master User code can access a variety of Z-Wave settings for the GC3 Security & Automation System.

**NOTE:** The GC3 Panel ignores any Command\_Class\_Basic commands it receives from other devices on the Z-Wave network.

## Navigate to the Smart Home Settings Menu

To navigate to the Smart Home Settings menu:

1. At the Home screen, tap **System Settings**.

*Smart Home Settings Button*

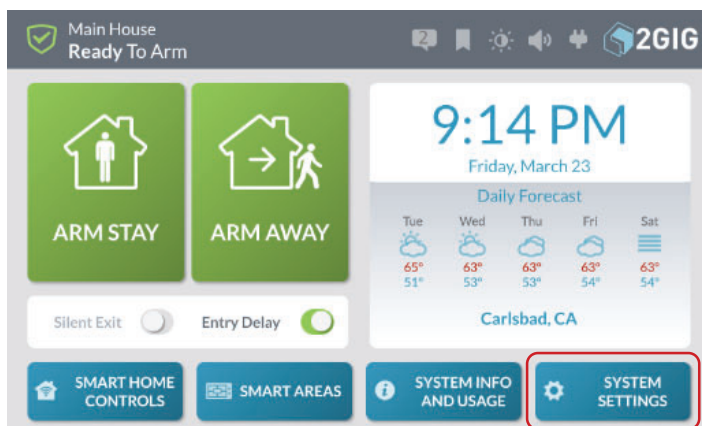

2. At the **Enter Your Code to Access the System Settings** screen, enter the system's four-digit Master User Code.

*Enter Your Code to Access the System Settings*

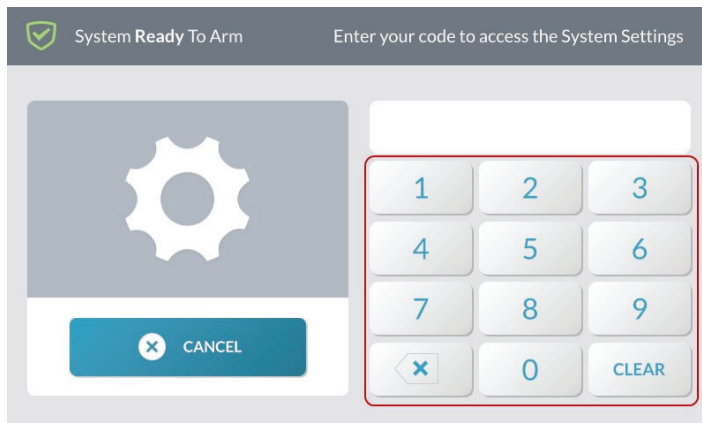

3. At the **System Settings** menu, tap **Smart Home Settings**.

*System Settings > Smart Home Settings*

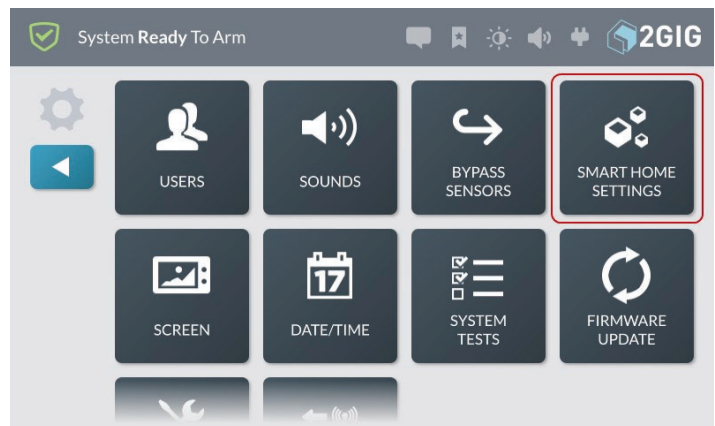

**NOTE:** Consult your installer to determine if the **Smart Home Settings** menu has been enabled on your system. Typically, this button is grayed out and not available because the factory default setting for this feature is Disabled but Visible.

This reveals the **Smart Home Settings** menu.

*Smart Home Settings Menu*

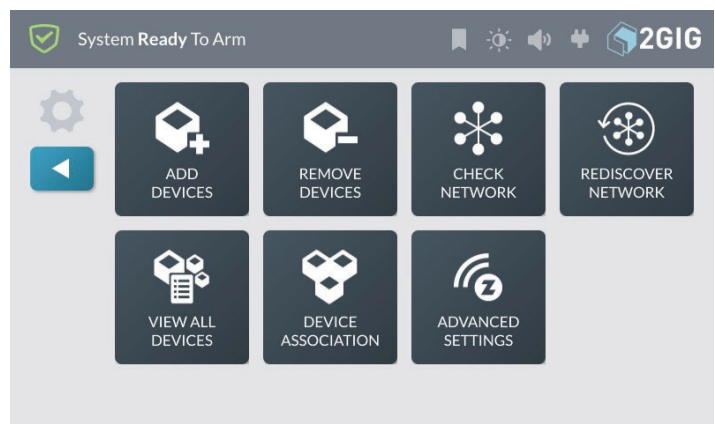

## Add a New Device

**TIP:** Manufacturers may add Z-Wave devices to a network in order to test them. To ensure successful addition of a device to the GC3 Control Panel, remove the new device before adding it to the network. See "Remove a Device."

To add a Z-Wave device to the network:

1. Navigate to the **Smart Home Settings** menu. See "Navigate to the Smart Home Settings Menu" above.
2. At the **Smart Home Settings** menu, tap **Add Devices**.

## Smart Home Settings—Add Devices

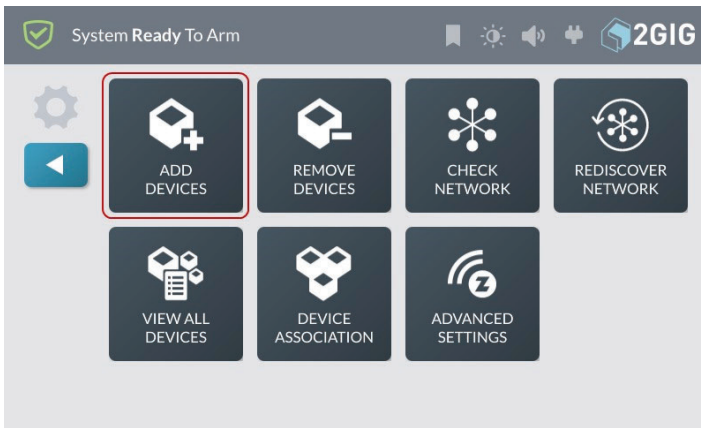

The **Listening for Devices to Add** screen reveals the **Add Devices Now** message.

### Listening for Devices to Add—Add Devices Now

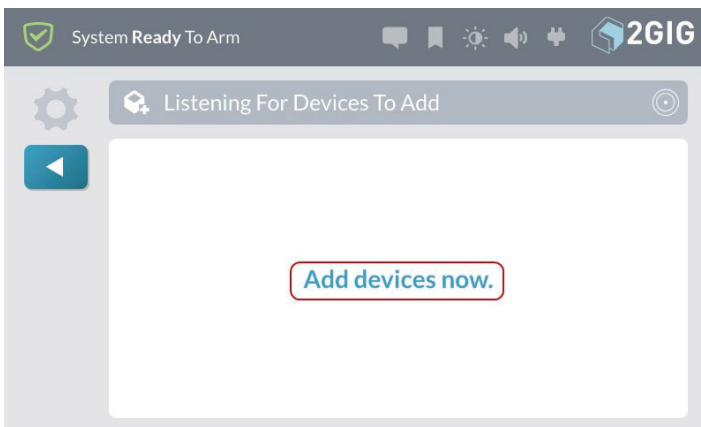

3. Walk to and trigger the device. For example, if you are adding a Z-Wave light bulb, turn the light bulb ON.

**TIP:** Typically, you can trigger a device on the network by either powering the device OFF/ON, pressing a button once or twice, or flipping a switch on the device. Every device is different.

When the system discovers a device, the **New device found** and **Adding device** message appears.

### Adding Device

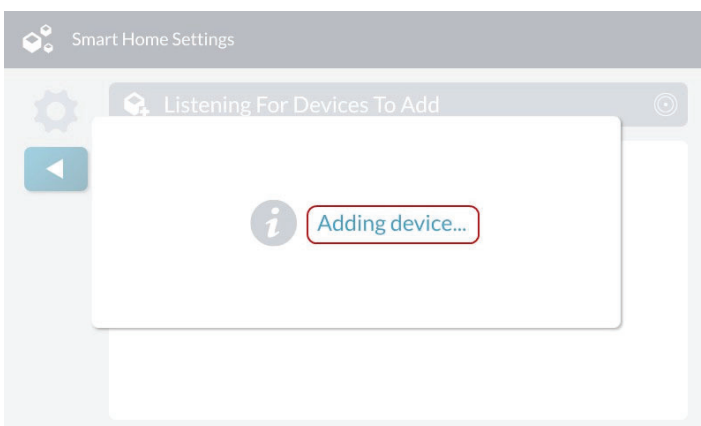

4. At the **New device was added to the system** message, tap **OK**.

### New Device was Added to the System Message

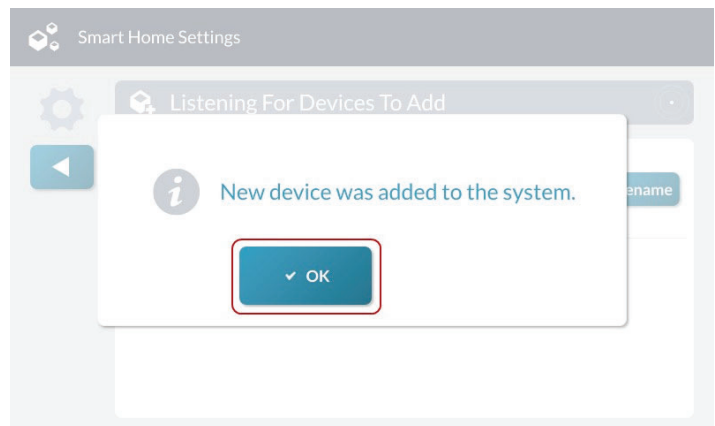

The newly-discovered device appears in the **Listening for Devices to Add** screen. Any device information captured during the discovery process appears below the device name.

**TIP:** The Control Panel issues a double-beep when a device is successfully added to the network.

### Listening for Devices to Add—New Device

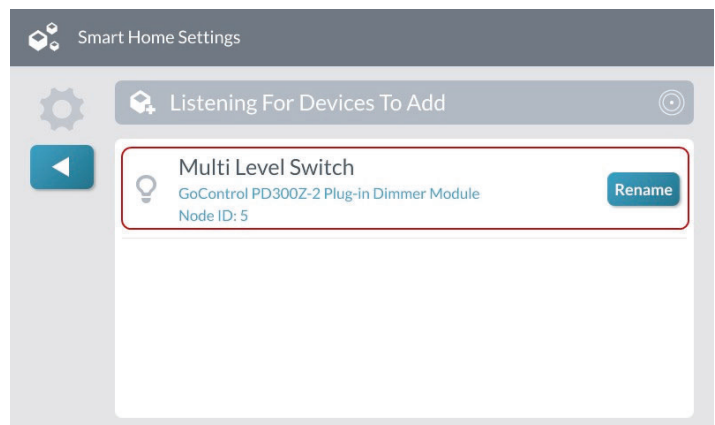

5. (Optional) At the **Listening for New Devices to Add** screen, tap **Rename**.

### Listening for Devices to Add—Rename

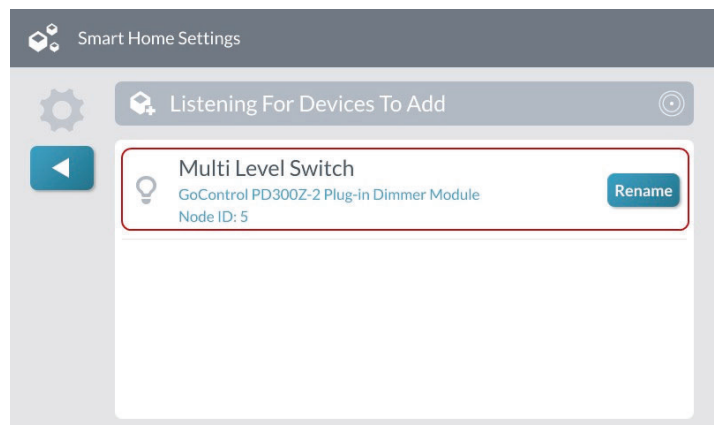



- At the **Enter a name for this device** screen, use touchscreen keypad to enter a new device name.

For example, enter: **Living Room Dimmer**

*Enter a name for this device*



- Tap **Done**.

The system reveals the new name on the **Listening for Devices to Add** screen.

*Listening for Devices to Add—New Device Name*

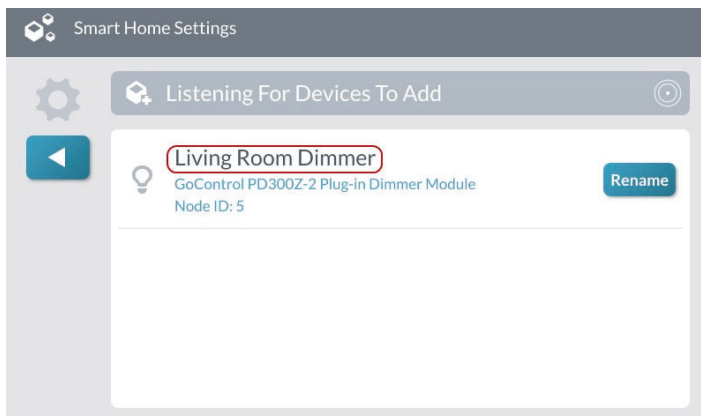

From the **Listening for Devices to Add** screen, you can continue by triggering the next desired device and then renaming it as needed.

- Tap  to return to the **Smart Home Settings** menu.

## Remove a Device

To remove a device from the network:

- Navigate to the **Smart Home Settings** menu. See “Navigate to the Smart Home Settings Menu.”
- At the **Smart Home Settings** menu, tap **Remove Devices**.

## Smart Home Settings—Remove Devices

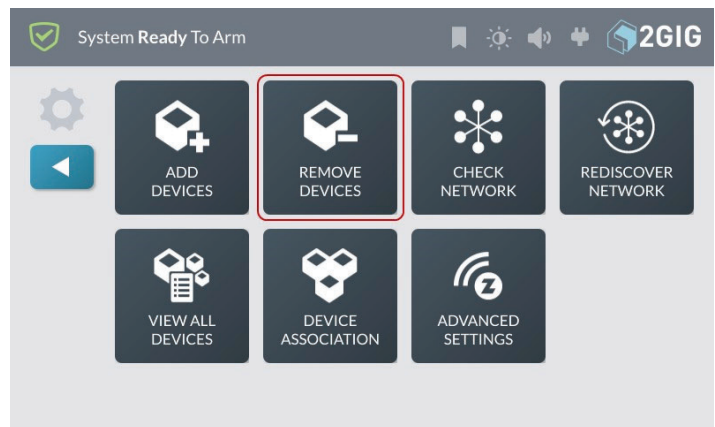

The Listening for Devices to Remove screen appears.

*Listening for Devices to Remove—Remove Devices Now*

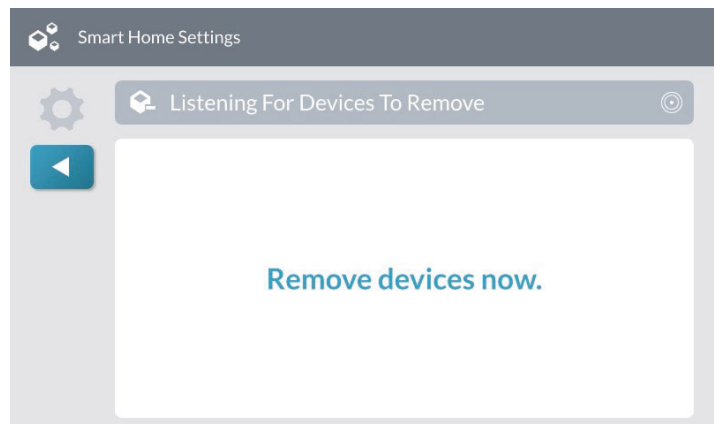

- Walk to and trigger the device on the network. For example, if you are removing a Z-Wave light bulb, turn the light bulb ON.

**TIP:** Typically, you can trigger a device on the network by either powering the device OFF/ON, pressing a button once or twice, or flipping a switch on the device. Every device is different. Consult the device’s installation guide for instructions.

When the system successfully removes the device, it appears on the **Listening for Devices to Remove** screen.

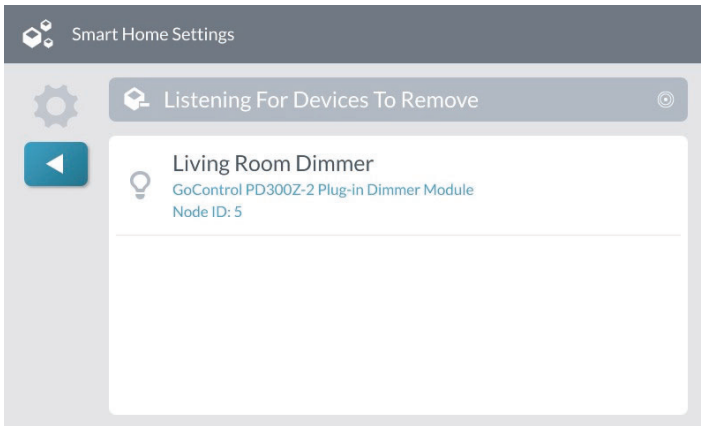

**TIP:** The Control Panel issues a double-beep when a device is successfully removed to the network.

4. Tap  to return to the Smart Home Settings menu.

### Check the Network

Use the **Check Network** feature to scan the smart home network for unresponsive nodes. This can take several minutes and some of the smart home functions will be unavailable until the check is complete.

To perform a network check:

1. Navigate to the **Smart Home Settings** menu. See “Navigate to the Smart Home Settings Menu.”
2. At the **Smart Home Settings** menu, tap **Check Network**.

Smart Home Settings—Check Network

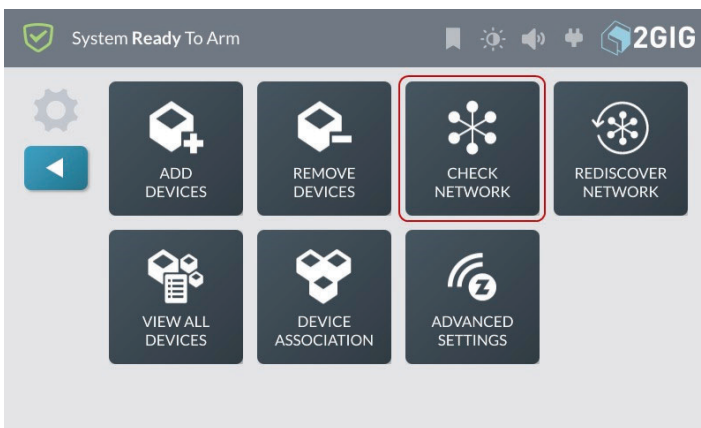

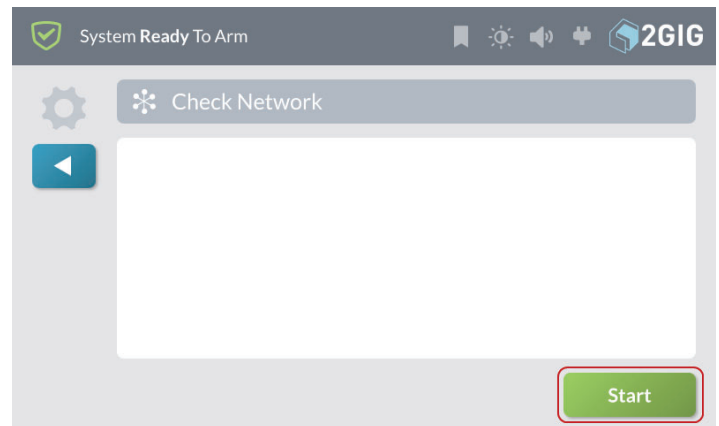

3. At the **Check Network** screen, tap **Start**.

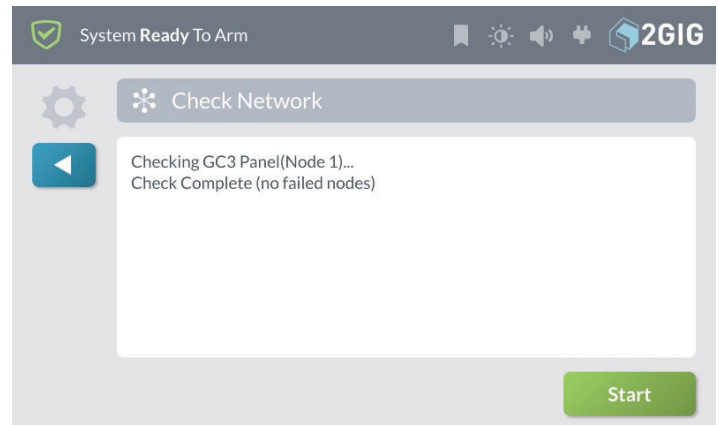

The system scans the network for unresponsive nodes and indicates the status of each scanned node.

Check Network—Status



4. When the Check Network is complete you can see the status of nodes in the network.
5. Tap  to return to the Smart Home Settings menu.

### Rediscover the Network

After adding or removing devices from the network, the final step is to rediscover the network. This updates the system’s communication routes so it communicates with the newly-added and previously added Z-Wave devices.

To rediscover the network:

1. Navigate to the **Smart Home Settings** menu. See “Navigate to the Smart Home Settings Menu.”
2. At the **Smart Home Settings** menu, tap **Rediscover Network**.

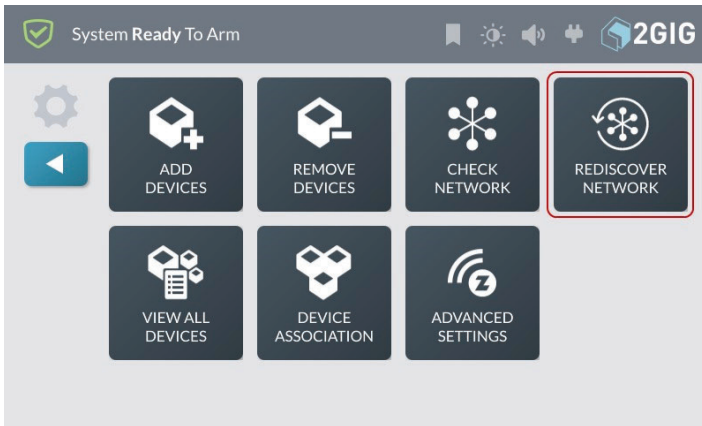

3. At the **Rediscover Network** screen, tap **Start**.

Rediscover Network—Start

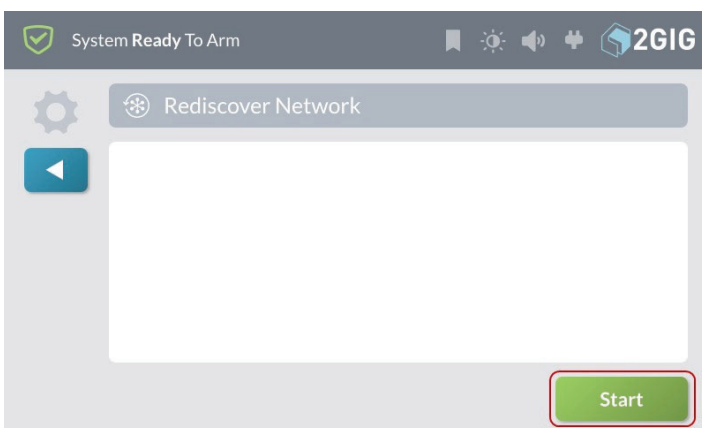

While the system is rediscovering the network it displays the status of each node as it is checked.

Rediscover Network—Status

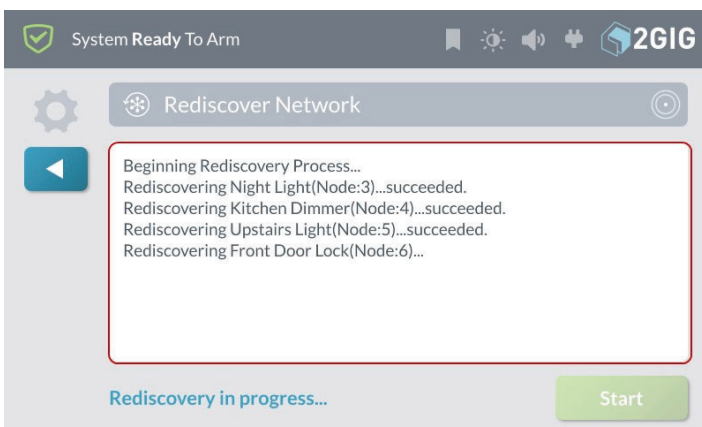

When the rediscovery is complete, the **Rediscover Network** screen with the **Start** button (shown above) appears again.

## Reset the Controller

You can reset the Z-Wave controller to remove all Z-Wave devices from the network and to reset the controller to its factory default state.

**NOTE:** Consult the device’s installation guide for instructions.

**NOTE:** Use this procedure only in the event that the network primary controller is missing or otherwise inoperable.

To reset the controller:

1. Navigate to the **Smart Home Settings** menu. See “Navigate to the Smart Home Settings Menu.”
2. At the **Smart Home Settings** menu, tap **Advanced Settings**.

Smart Home Settings—Advanced Settings

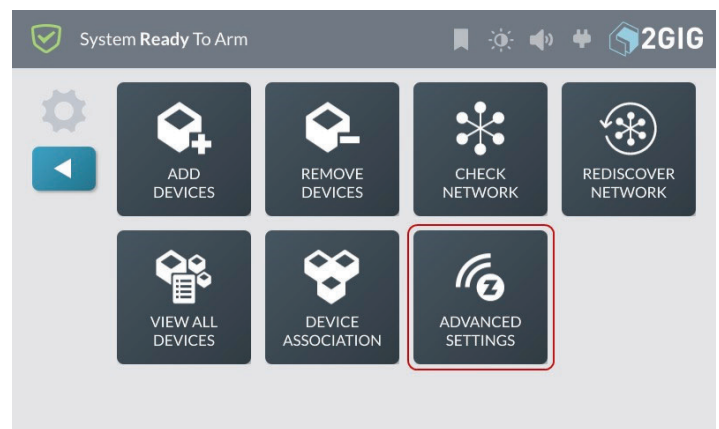

3. At the **Advanced Settings** menu, tap **Reset Controller**.

Advanced Settings—Reset Controller

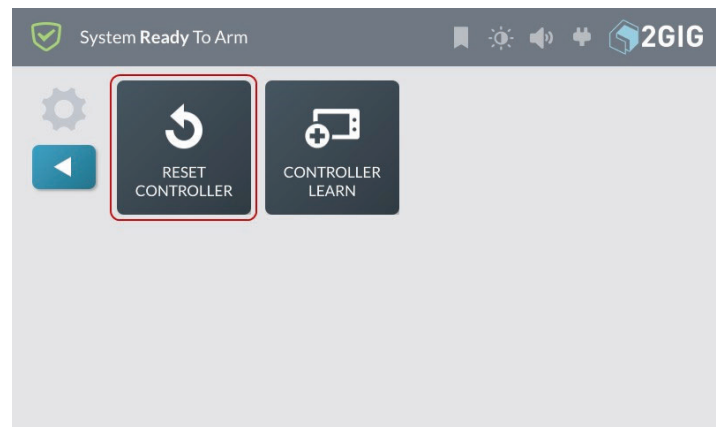

4. At the **Reset the Z-Wave Controller** screen, tap **Reset Controller**.

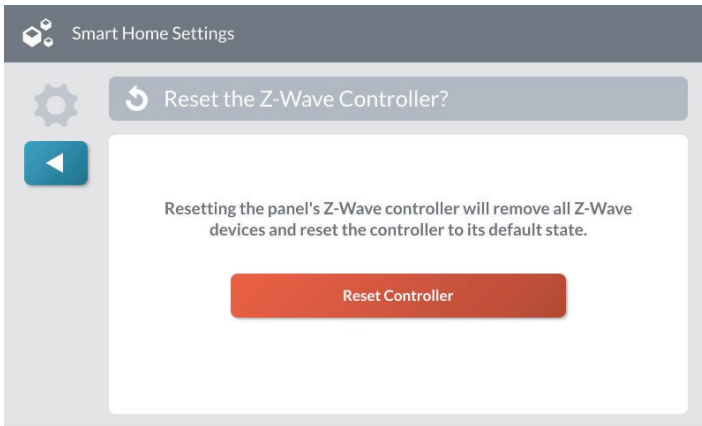

**NOTE:** Resetting the controller will delete all node information from the GC3 Control Panel. Any devices that were part of the mesh network will need to be manually removed from the network before they can be added to a network.

While the controller resets, the **Working** message appears.

Reset the Z-Wave Controller—Working

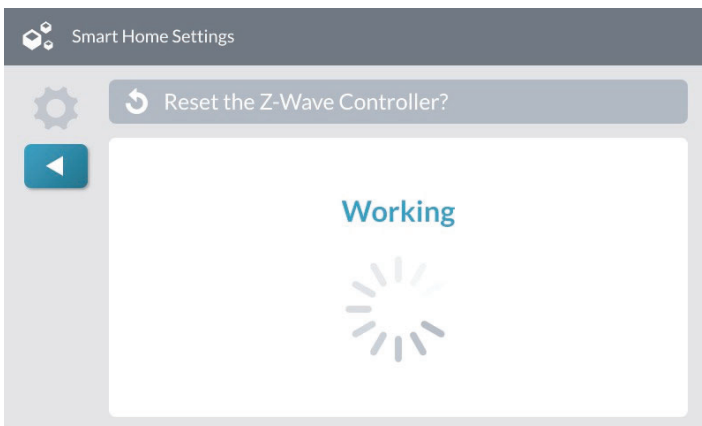

5. When the controller is reset, the following message appears. Tap **OK** or wait a few seconds for the message to close automatically.

Z-Wave Controller Reset Message

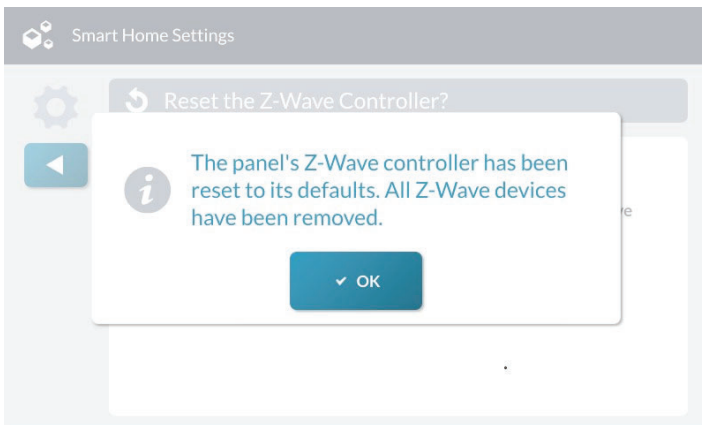

## View All Devices

The View All Devices function lists all Z-Wave devices in the Control Panel network and provides the following options, depending on the type and current status of a device:

- » **Configure**
- » **Hide/Unhide**
- » **Identify**
- » **Remove**
- » **Rename**
- » **Replace**

To view all network devices and access these options:

1. Navigate to the **Smart Home Settings** menu. See “Navigate to the Smart Home Settings Menu.”
2. At the Smart Home Settings menu, tap **View All Devices**.

Smart Home Settings—View All Devices

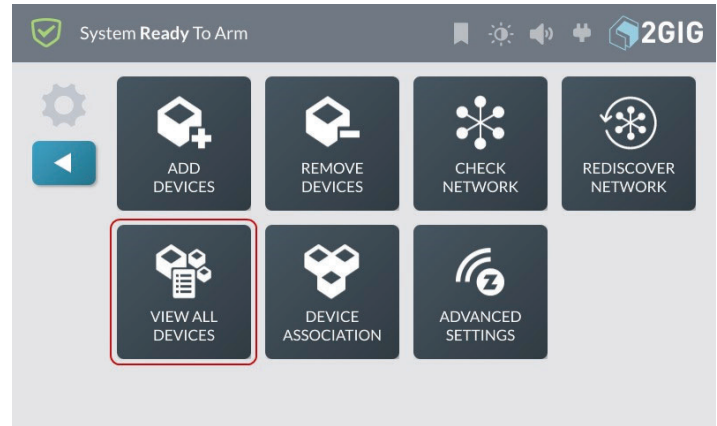

3. At the **Smart Home Devices** screen, review the list of devices. If you have added several devices, you can swipe up and down to move through the list.

Smart Home – View All Devices

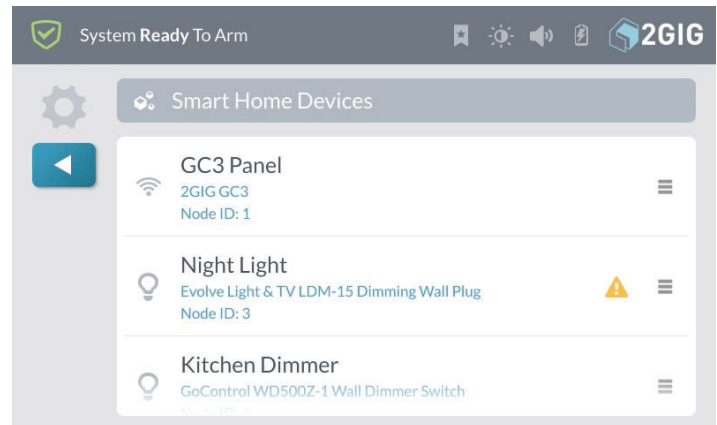

4. To view the options available for a device, tap the menu button (☰).

## Configure

The Configure option is device dependent, and only appears when a Z-Wave device has special configuration options.

### Smart Home – Configure Option

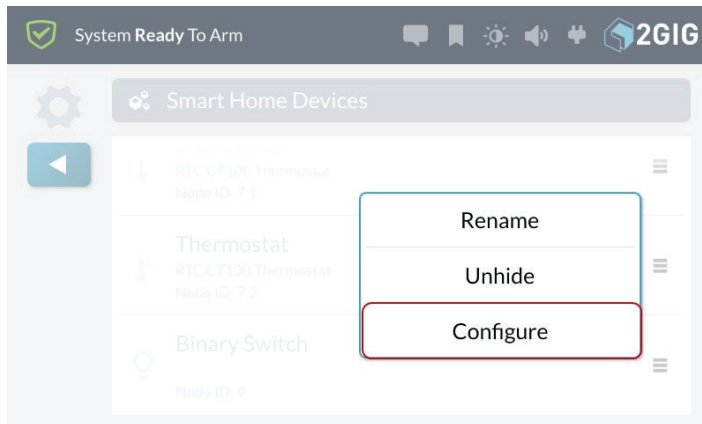

This option lets you enter configuration parameters that are found in the device's user guide.

## Hide/Unhide

The Hide/Unhide option determines whether or not a device appears on Smart Home Control screens.

To hide a device on Smart Home Control screens:

1. Tap the menu button (☰) next to the device and tap **Hide**.

### Smart Home Devices – Hide

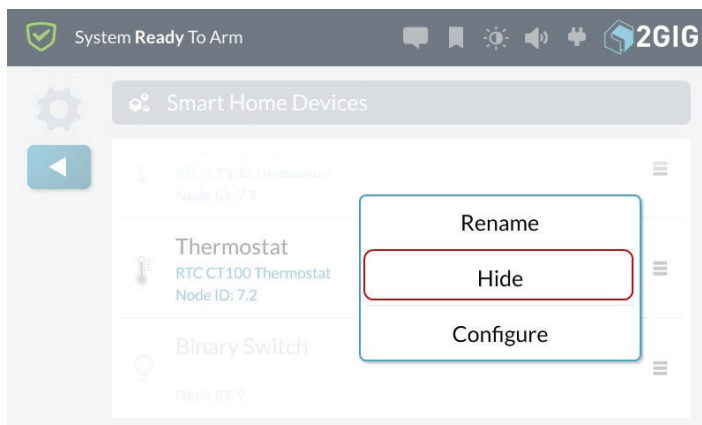

A confirmation screen appears.

### Smart Home Devices – Hide Confirmation

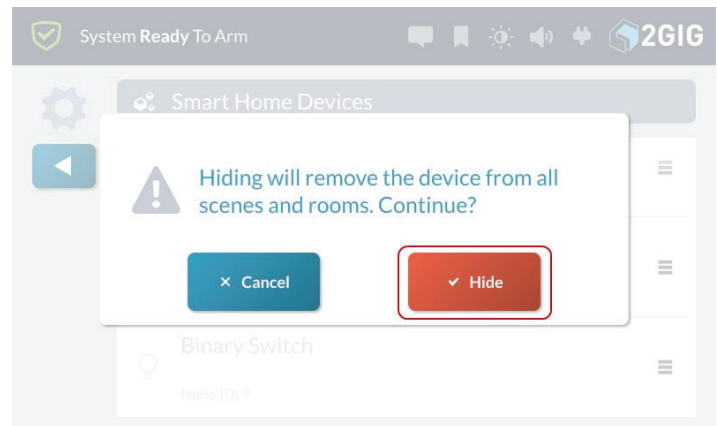

2. Tap **Hide** to prevent the device from appearing on **Smart Home Control** screens.

The device appears in gray text on **Smart Home Devices** screen.

### Smart Home Devices – Hidden Device

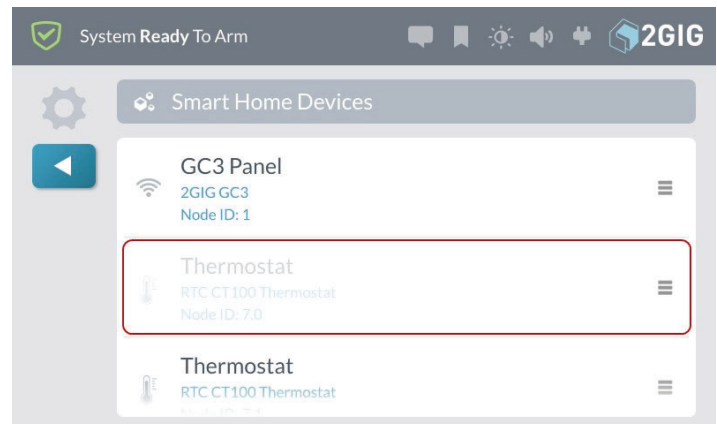

3. Tap  to return to the **Smart Home Settings** menu.

To make a hidden device visible on Smart Home Control screens:

1. Tap the menu button (☰) next to the device and tap **Unhide**.

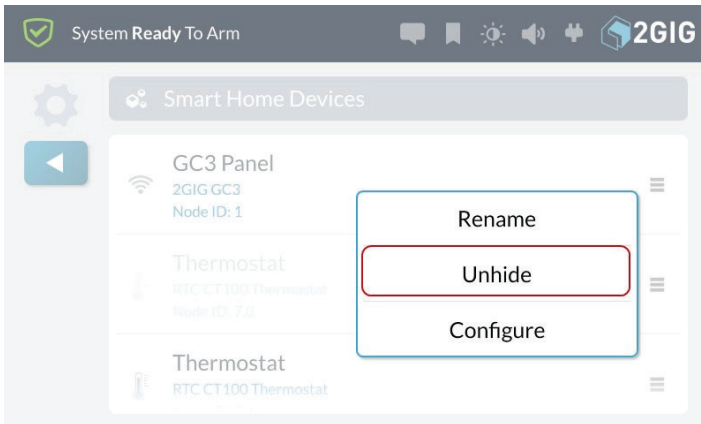

The menu closes, the device appears in normal text on the **Smart Home Devices** screen, and it also appears in Smart Home Control screens.

Smart Home Devices – Unhidden Device

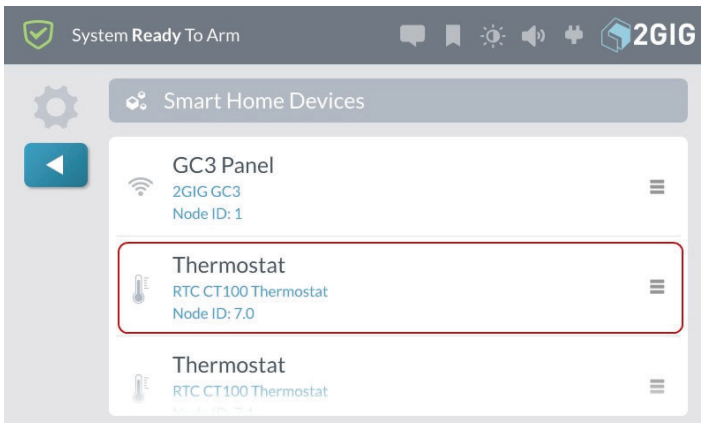

2. Tap  to return to the **Smart Home Settings** menu.

## Identify

This option lets you identify a device from the control panel. Tapping **Identify** activates the device (for example, a light module will turn on and then turn off). This feature can be helpful if you add multiple devices to the system without renaming them at the time of installation.

Smart Home Devices – Identify

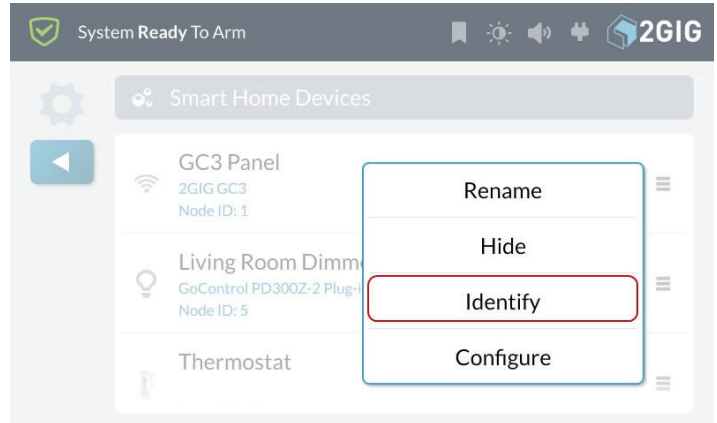

## Remove

This option lets you remove a non-communicating node from the system. This option only appears for a device that is not communicating with the system.

**NOTE:** Non-communicating devices are indicated by an alert icon (⚠).

To remove a non-communicating node from the system:

1. Tap the menu button () next to the non-communicating device and tap **Remove**.

Smart Home Devices – Remove

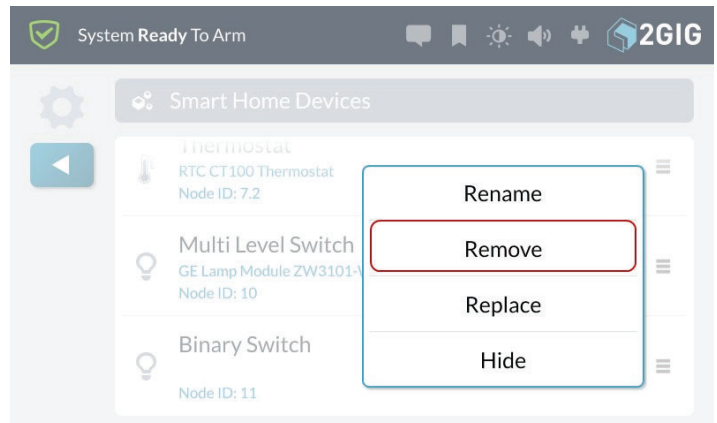

A confirmation screen appears.

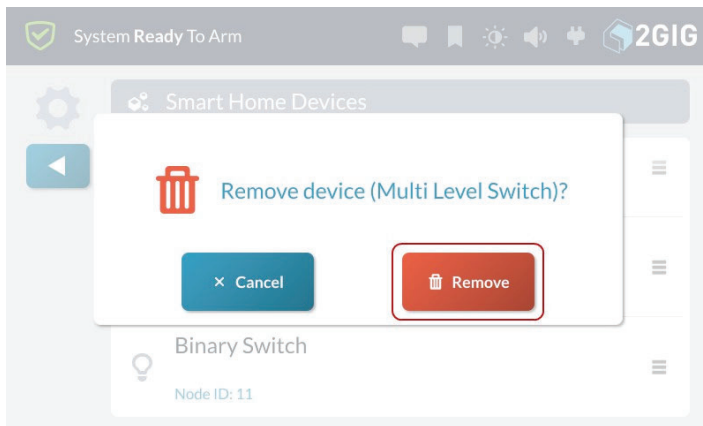

2. Tap **Remove** to delete the device from the network.
3. Tap **⏪** to return to the Smart Home Settings menu.

### Rename

This option lets you rename devices that have already been added to the system.

To rename a device:

1. Tap the menu button (**☰**) next to the device and tap **Rename**.

Smart Home Devices – Rename

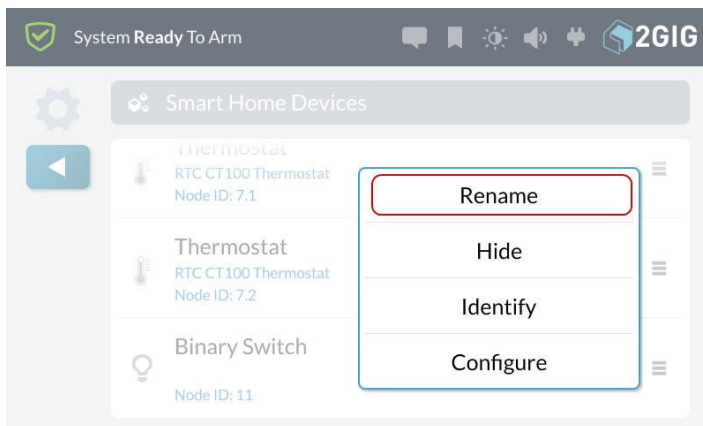

An onscreen keyboard appears.

Smart Home Devices – Enter a name for the device



2. Enter a new name for the device and tap **Done**.

The system reveals the new name on the Smart Home Devices screen.

Smart Home Devices – New Device Name

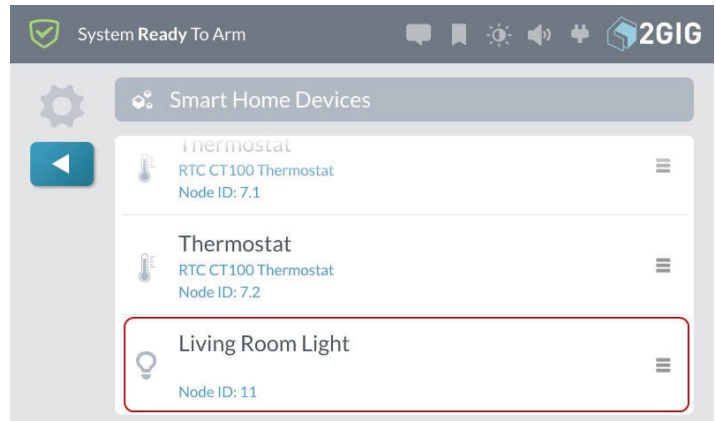

3. Tap **⏪** to return to the **Smart Home Settings** menu.

### Replace

This feature lets you replace a non-communicating device with an identical device maintaining the same node number and other mesh network settings. This makes it easier to replace a device that is no longer working and is only available for a non-communicating device.

**NOTE:** Non-communicating devices are indicated by an alert icon (**⚠**).

To replace a non-communicating device:

1. Tap the menu button (**☰**) next to the non-communicating device and tap **Replace**.

Smart Home Devices – Non-Communicating Device

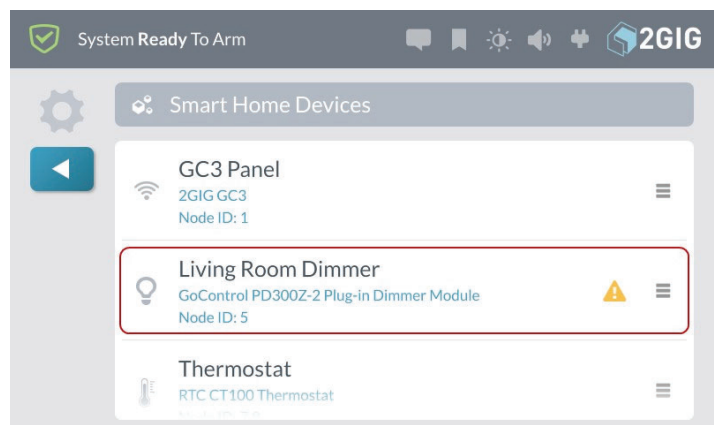

## 2. Tap **Replace**.

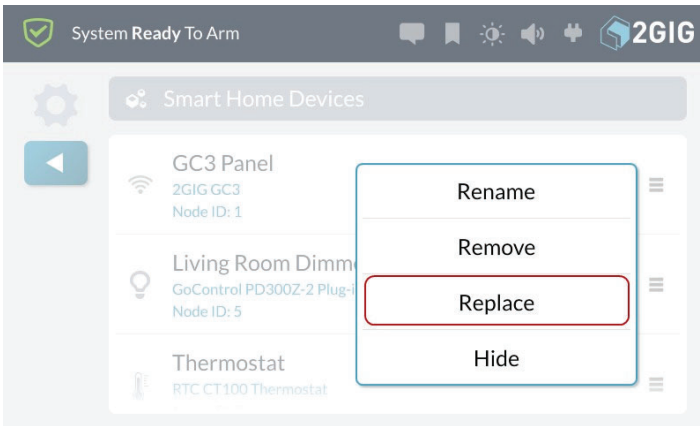

A **Listening For Replacement Device** screen appears.

*Smart Home Devices – Listening For Replacement Device*

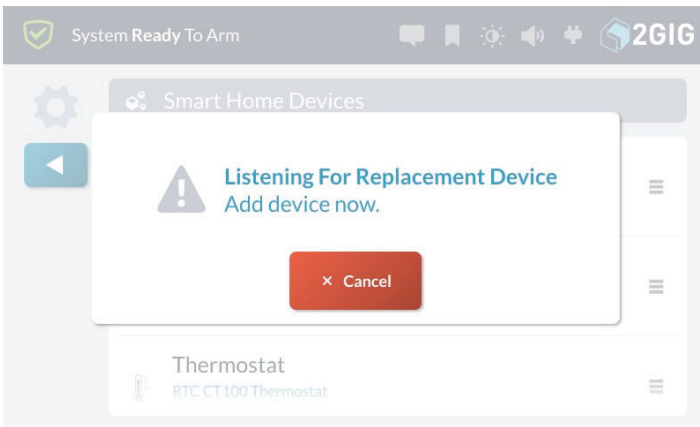

3. Walk to and trigger the replacement device on the network. For example, if you are replacing a Z-Wave light bulb, turn the light bulb ON.

A confirmation dialog appears when the replacement is finished.

*Smart Home Devices – Replacement Finished*

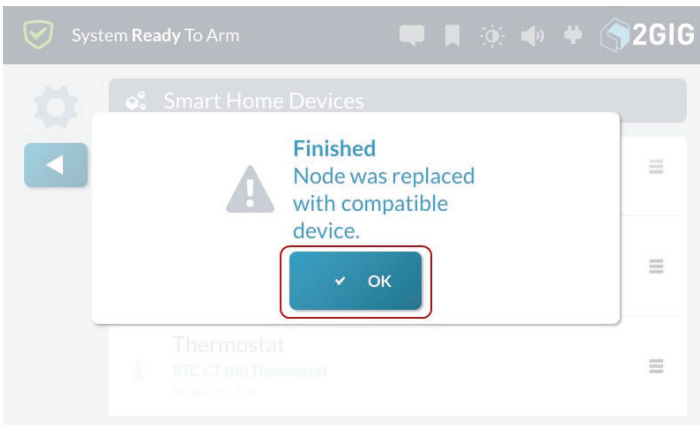

4. Tap **OK** to close the confirmation dialog.

5. Tap  to return to the **Smart Home Settings** menu.

## Associating Z-Wave Devices

The Association function provides a means of enabling individual network devices to communicate directly with each other.

To associate Z-Wave devices:

1. At the **Home** screen, tap **System Settings**.

*Home—System Settings*

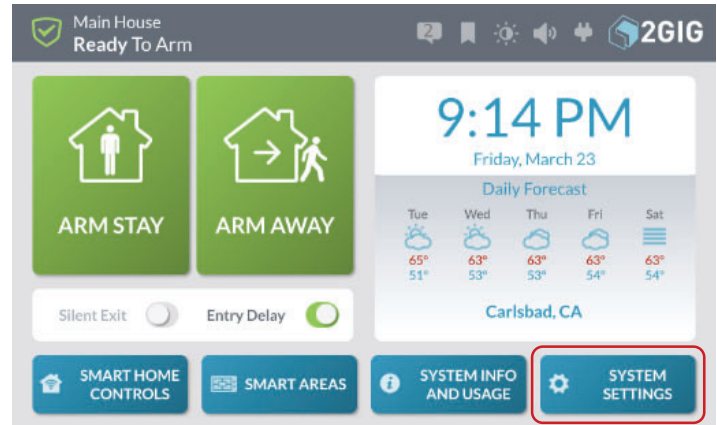

2. Enter the *Master User Code* to access the **System Settings** screen.

*Enter Master User Code*

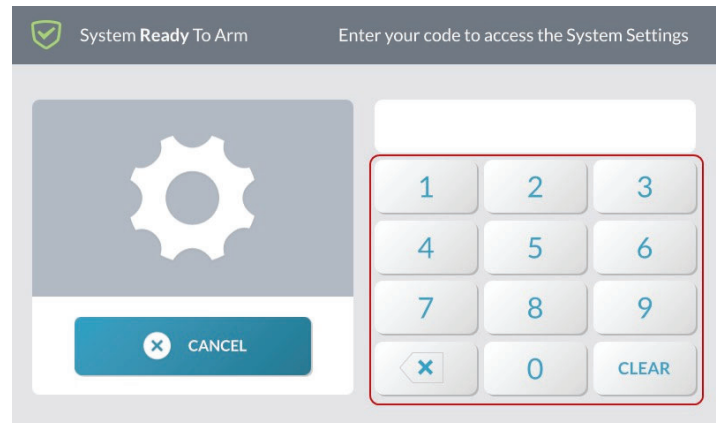

3. At the **System Settings** menu, tap **Smart Home Settings** on both Control Panels.



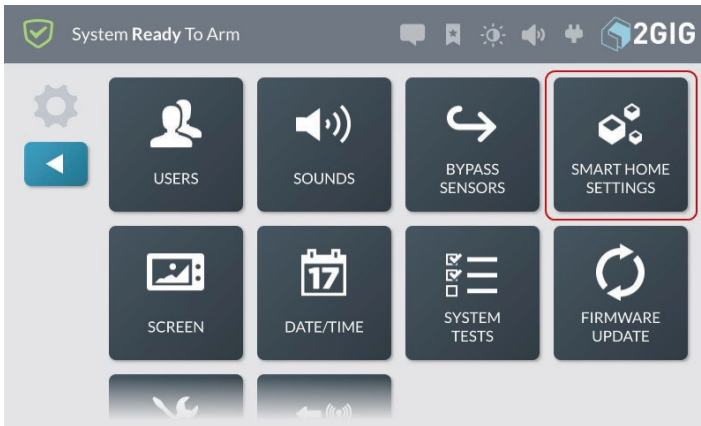

- At the **Smart Home Settings** menu, tap **Device Association**.

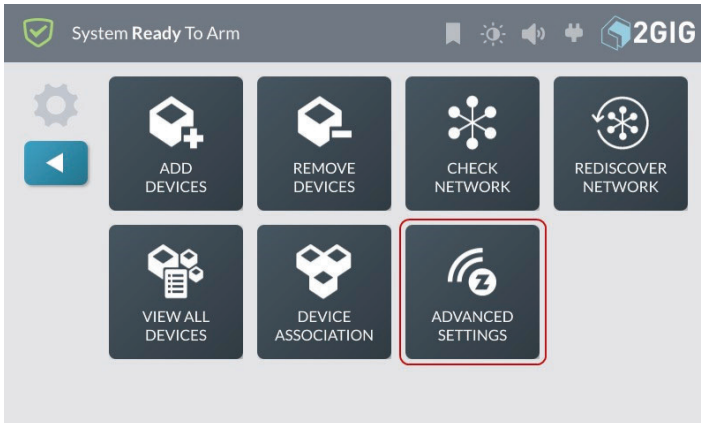

- At the **Z-Wave Association** screen, tap the **Manage** button next to the device that will act as the controller.

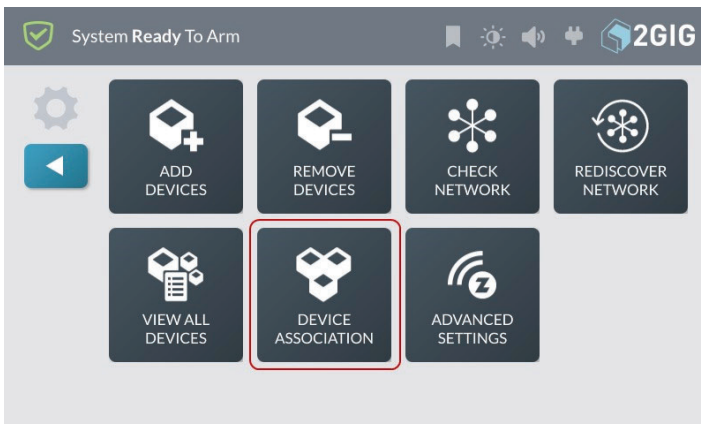

- Tap **Edit Group** to select the Group for the association.

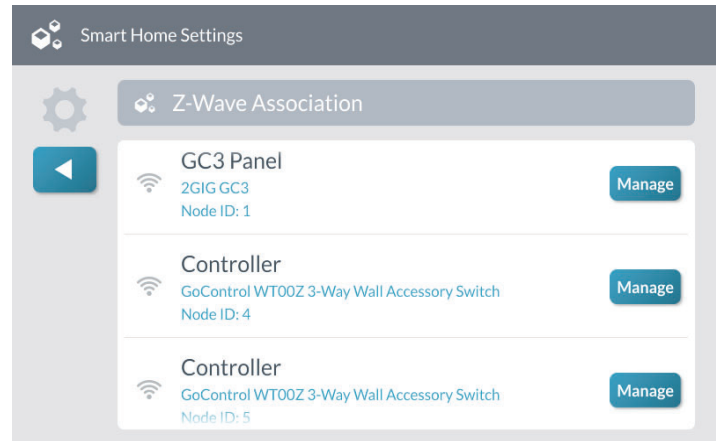

- Select the devices to be associated with the controller device and tap .

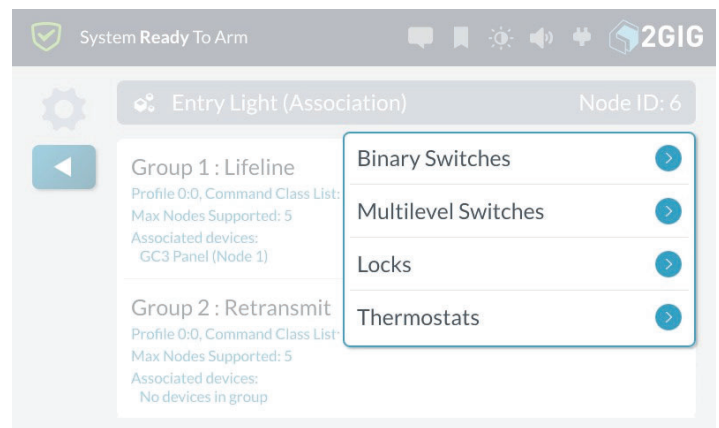

- Tap to return to the **Smart Home Settings** menu.

**NOTE:** Refer to device documentation for information about the association groups supported by the device.

## Learn Controller

The GC3 Panel can be added to an existing Z-Wave network as a “secondary” controller (this process is also called “copy” or “replication”).

When the GC3 Panel acts as a secondary controller, devices can only be added to or removed from the Z-Wave network at the primary controller. Other than that, all functions are available to either controller.

To add the GC3 Panel as a secondary controller for an existing Z-Wave network:

1. At the existing controller, add the GC3 Panel to the Z-Wave network. (If the existing controller is a GC3 Panel, see “Add a New Device.” Otherwise, refer to the documentation that came with the Z-Wave controller.)
2. At the **Home** screen on the secondary GC3 Panel, tap **System Settings**.

Home—System Settings

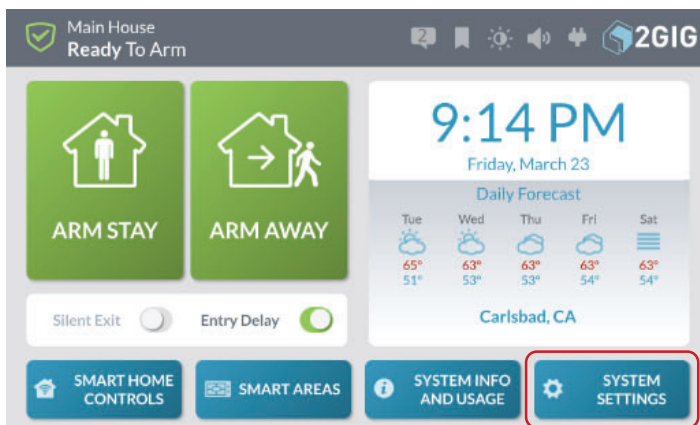

3. Enter the *Master User Code* to access the **System Settings** screen.

Enter Master Users Code

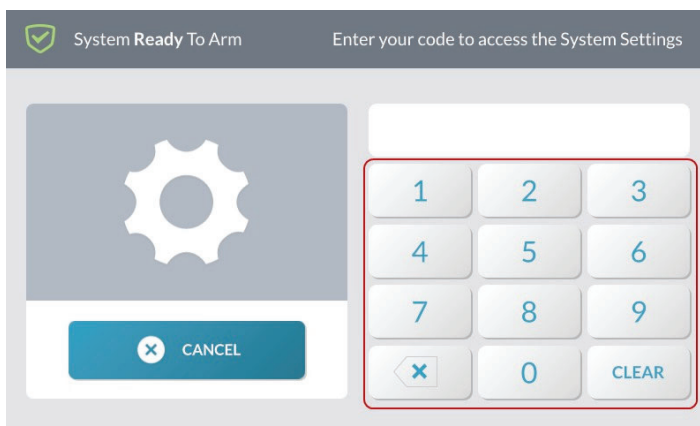

4. At the **System Settings** menu, tap **Smart Home Settings**.

System Settings—Smart Home Settings

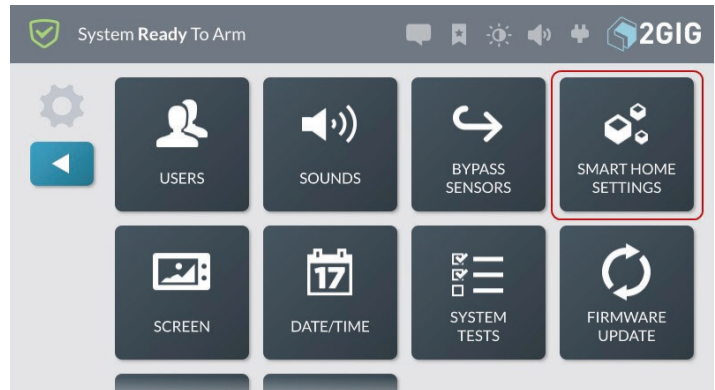

5. At the **Smart Home Settings** menu, tap **Advanced Settings**.

Smart Home Settings—Advanced Settings

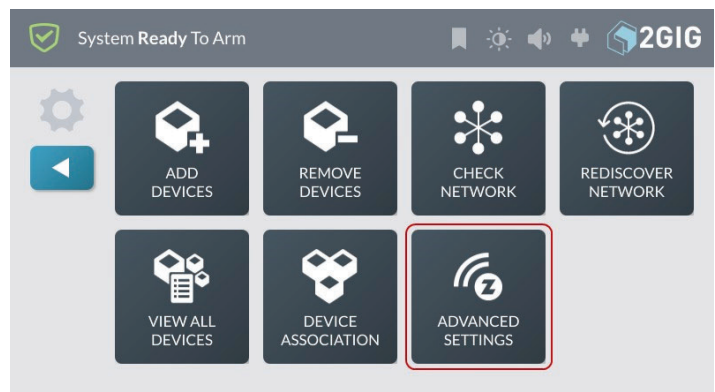

6. At the **Advanced Settings** menu, tap **Controller Learn**.

Advanced Settings—Controller Learn

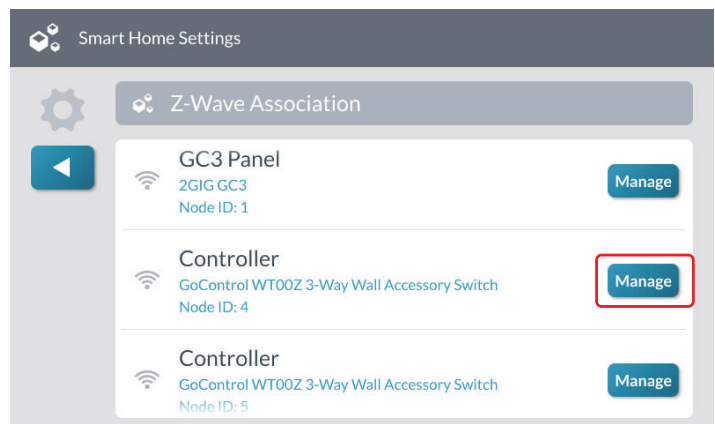

The GC3 Panel displays a “Learning Z-Wave Controller” message and waits for a signal from the primary controller. The synchronization takes time, depending upon the number of Z- Wave devices in the network.

**NOTE:** If a new Z-Wave device is added to the network, the secondary controller must be re-learned into the network

## Screen

Use the **Screen** feature to adjust the screen brightness, dim brightness, backlight timeout, and to place the touchscreen into clean mode.

**NOTE:** To use this feature, you must know the four-digit Master User Code.

### Navigating to Screen

1. At the **Home** screen, tap **System Settings**.

*Home Screen > System Settings*

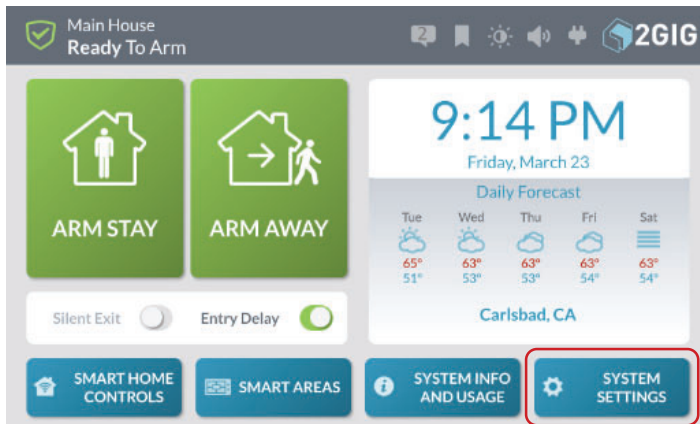

2. At the **Enter Your Code to Access the System Settings** screen, enter an active, four-digit user code.

*Enter Your Code to Access the System Settings*

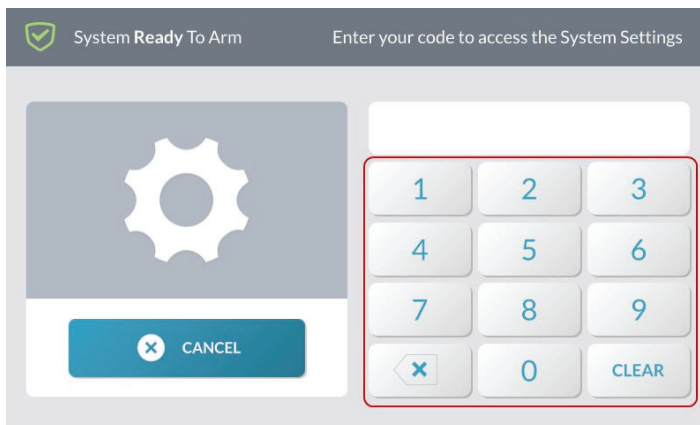

3. At the **System Settings** menu, tap **Screen**.

### System Settings > Screen

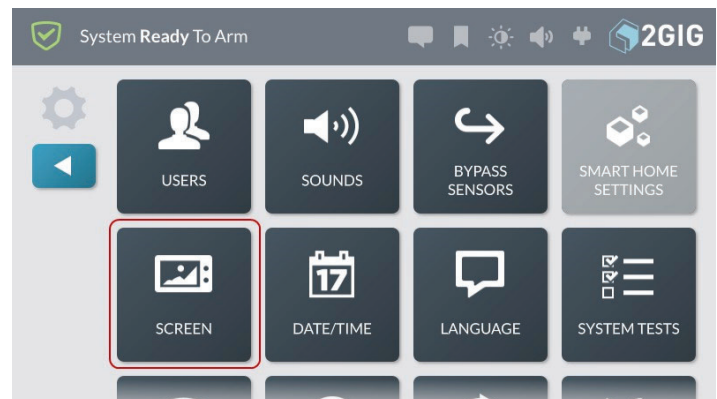

This reveals the **Screen** screen.

### Adjusting the Screen Brightness

**NOTE:** This feature is available only when the system is set to demo mode.



Adjust the screen brightness to improve the readability of the text and images on the touchscreen and to avoid eye discomfort in darker environments or at night.

To adjust the screen brightness:

1. Navigate to **Screen**. See “Navigating to Screen” on the previous page.
2. Swipe the **Screen Brightness** slide control to the left or right to decrease or increase the brightness.

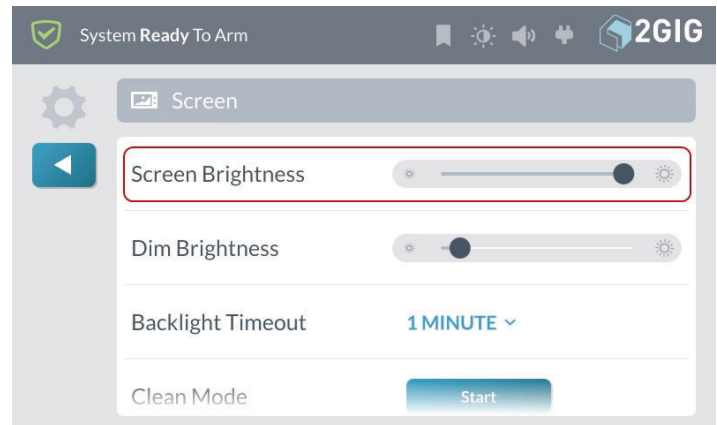
*Screen—Screen Brightness*



3. Tap  to return to the **System Settings** menu.
4. Tap  to return to the **Home** screen.

### Adjusting the Dim Brightness



The Dim Brightness refers to the brightness level of the touchscreen when backlit.

To adjust the dim brightness:

1. Navigate to **Screen**. See “Navigating to Screen” on the previous page.
2. On the **Dim Brightness** slide control, swipe left to lower the dimmer brightness. Swipe right to increase the dimmer brightness.

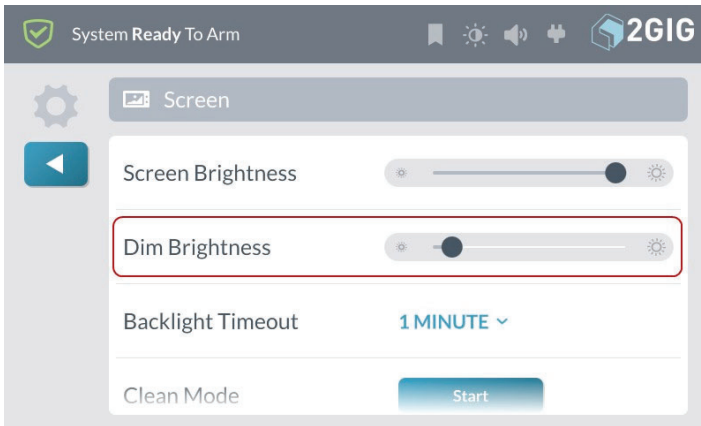
## Screen—Dim Brightness



3. Tap  to return to the **System Settings** menu.
4. Tap  to return to the **Home** screen.

## Set the Date/Time

To set the system date:

1. At the **Home** screen, tap **System Settings**.
2. At the **System Settings** menu, enter the system's Master User Code.
3. Tap **Date/Time**.

The system reveals the **Date/Time** screen.

### Date/Time Screen

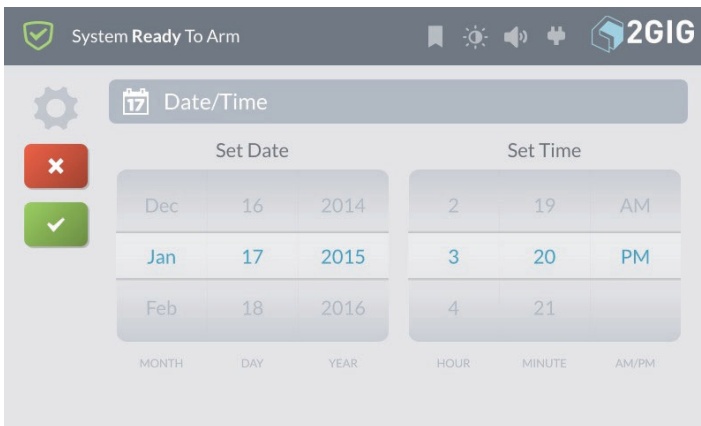

4. Scroll through the date options select the appropriate **Month**, **Day**, and **Year**.
5. Scroll through the time options to select the appropriate **Hour**, **Minute**, and choose between **AM/PM**.
6. Tap  when finished.

## Language

To set the system language:

1. At the Home screen, tap **System Settings**.

### System Settings Menu

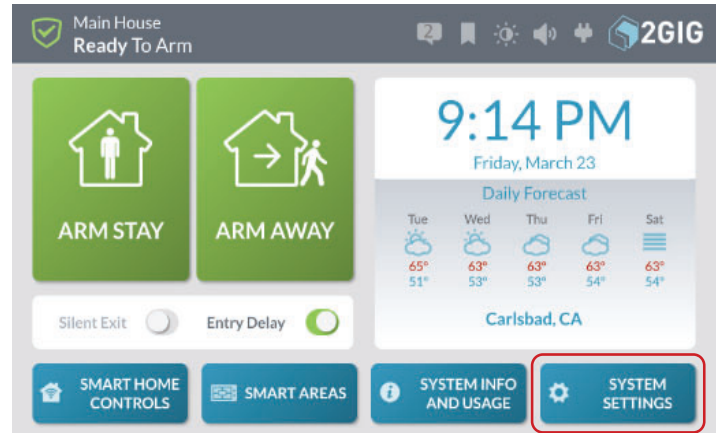

2. Enter the Master User Code to access the **System Settings** menu.
3. Tap **Language**.

### Language Menu

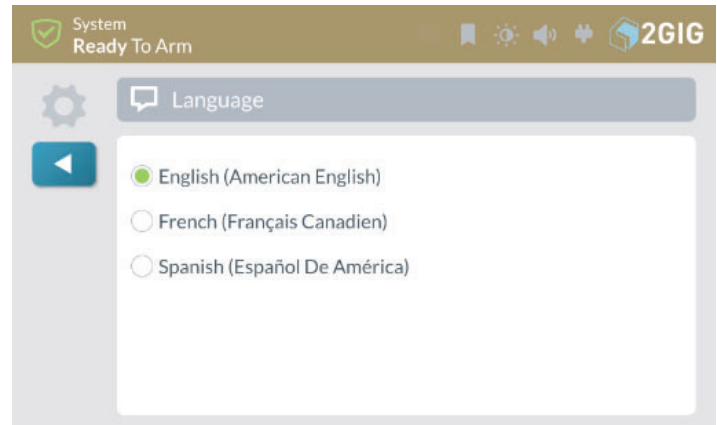

4. Select English, French, or Spanish to change System Language.

## System Tests

To ensure continued protection and proper system operations, it is important to perform a sensor and console test on a weekly basis.

**NOTE:** To use this feature, you must know the four-digit Master User Code.

## Navigate to System Tests

To navigate to the System Tests module:

1. At the **Home** screen, tap **System Settings**.

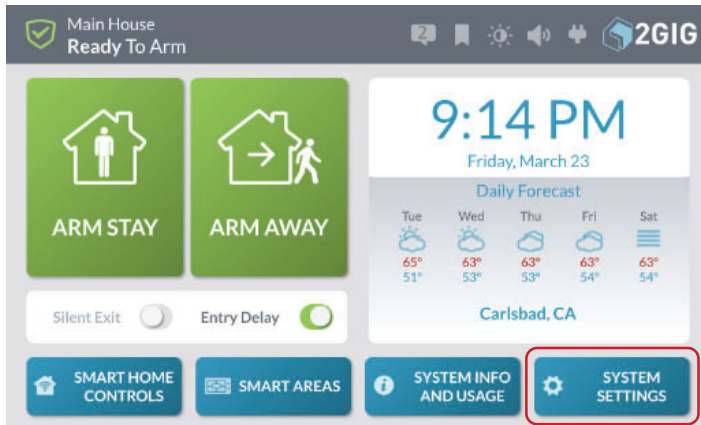

2. Enter the *Master User Code* to access the **System Settings** menu.

### System Tests

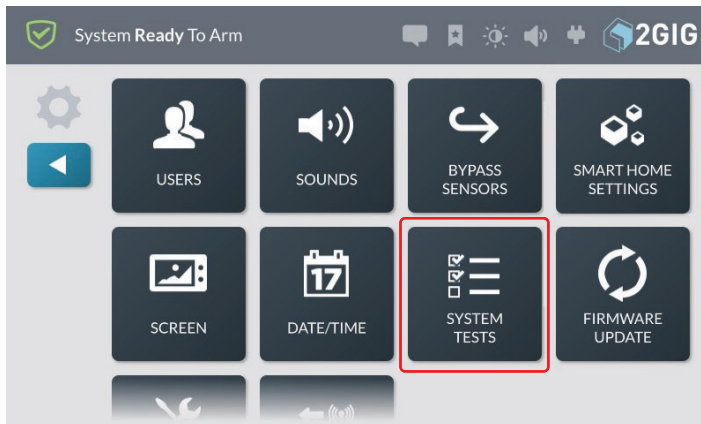

3. Tap **System Tests**.

This reveals the **Systems Tests** menu.

### Systems Test Menu

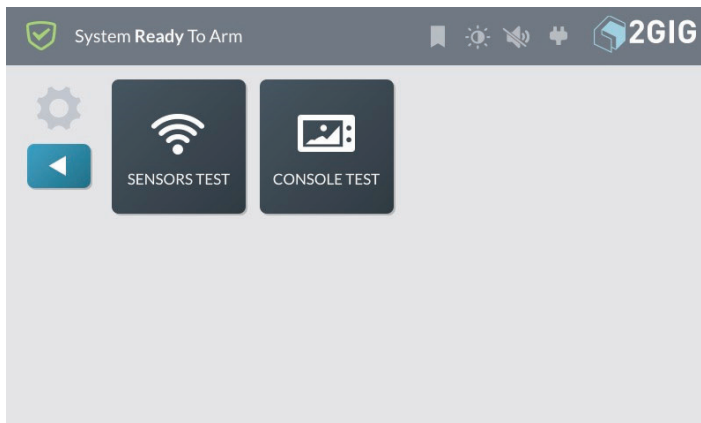

4. Tap one of these buttons to choose the test type:

- » **Sensors Test:** Tests the wireless signal between the GC3 Panel and installed sensors. See “Performing a Sensors Test” below.
- » **Console Test:** Tests the function of the GC3 Panel’s audio and buttons. See “Performing a Console Test” on the next page.

## Performing a Sensors Test

To perform a sensors test:

1. Navigate to the **System Tests** menu. See “Navigate to System Tests.”

### Sensors Test



2. Tap **Sensors Test**.  
This places the GC3 Panel into Walk Test Mode and transmits a **Walk Test Started** report to the Central Station.
3. At the **Sensors Test** screen, review the list of sensors installed with your system.

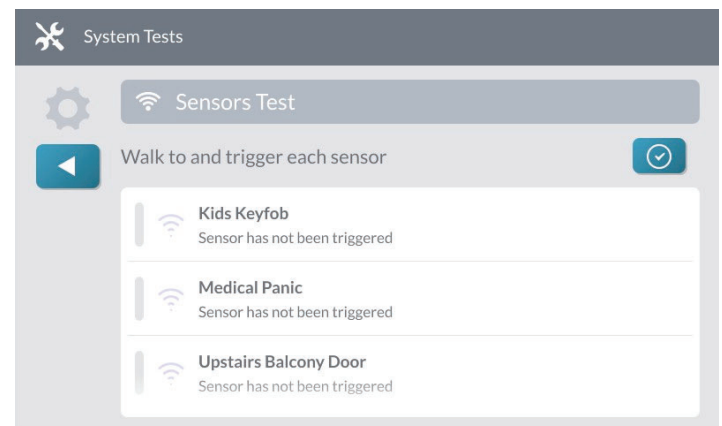

4. Walk to and trigger each sensor in the list:
  - » **For Door/Window Contact Sensors:** Open and then close the door or window.
  - » **For Motion Detectors:** Stay outside of the protected area for five (5) minutes. Then, walk through the area.
  - » **For Panic Buttons, Keyfobs, and Wireless Keypads:** Press a key or button on the device.

- » **For Smoke/Heat/Freeze Alarms, Carbon Monoxide Detectors, or Glass Break Detectors:** Press the product's Test button. See the Installation Instructions that came with the product for help locating the test button.

Successful Tests - GREEN Bar

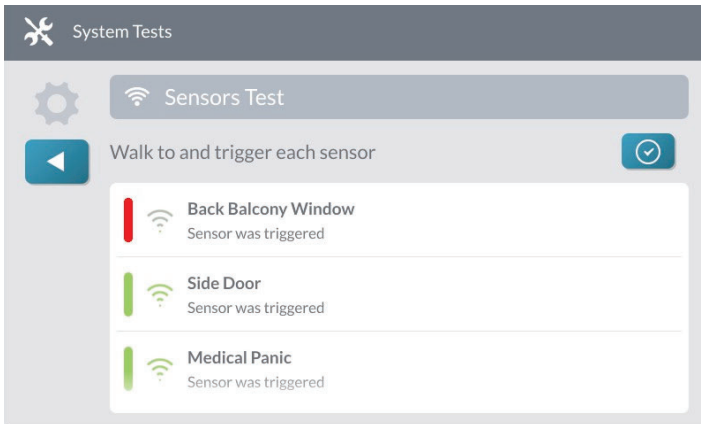

When tests are successful, a **GREEN** bar appears to the left of the test name. This indicates the sensor is operating and the wireless signal strength was good.

**WARNING!!** If a **RED** bar appears, it indicates the test failed. To protect your dwelling and its occupants from adverse events, contact your 2GIG alarm dealer for technical assistance.

5. Tap the button.

### Performing a Console Test

To perform a console test:

1. Navigate to the **System Tests** menu. See “Navigate to System Tests.”

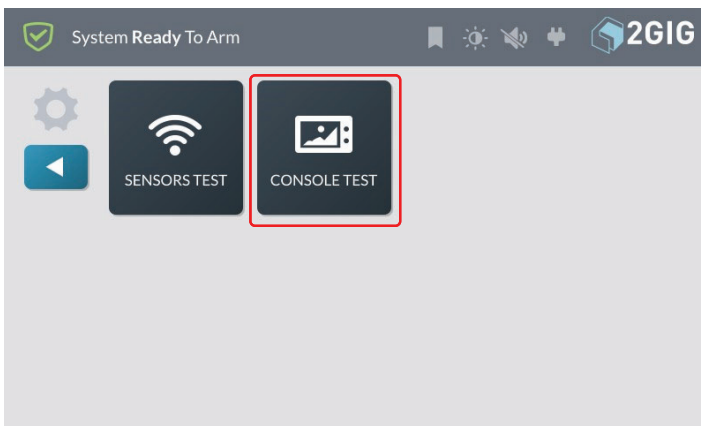

2. Tap **Console Test**. This reveals the **Console Test** screen.

Perform Test

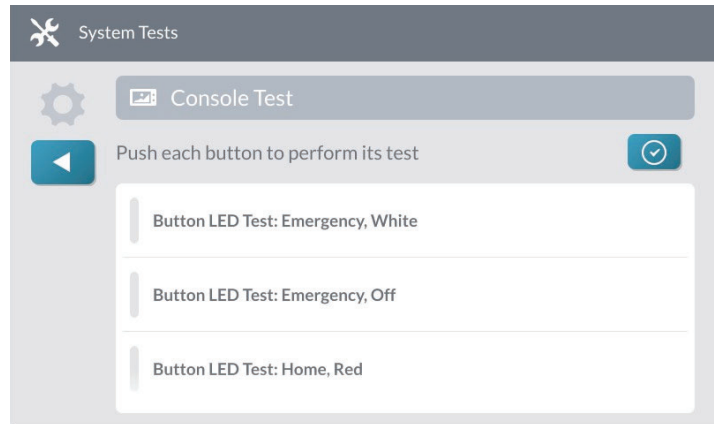

3. Tap **Button LED Test; Emergency, White**. A confirmation message appears.

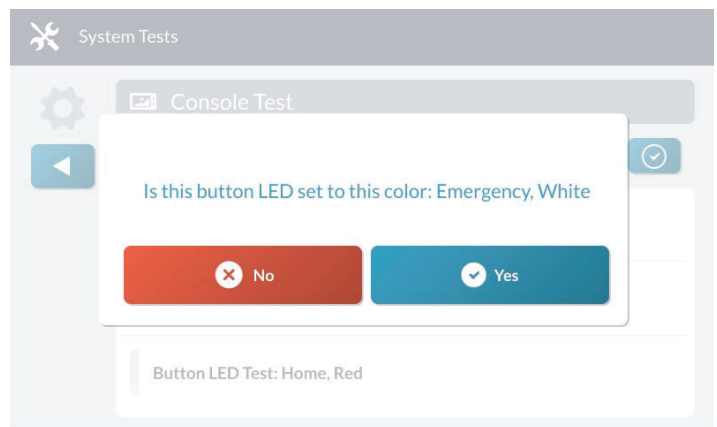

4. Tap one of the following buttons:
  - » **No:** Tap this button if the LED does not match what is described in the message.
  - » **Yes:** Tap this button if the LED matches what is described in the message.
5. Repeat the above steps for each listed **Button LED** test.
6. Scroll down the screen and tap **Siren Audio Test**. This tests the internal siren on the GC3 Panel. When the test is complete, tap one of these buttons:
  - » **No:** Tap this button if you did not hear the siren.
  - » **Yes:** Tap this button if you heard the siren.
7. Scroll down the screen and tap **Sounder Audio Test**. This tests the sounder on the GC3 Panel. When the test is complete, tap one of these buttons:
  - » **No:** Tap this button if you did not hear the sounder.
  - » **Yes:** Tap this button if you heard the sounder.

- If any of the tests failed, a **RED** bar appears next to the test name as shown in the example below. Contact your 2GIG alarm dealer for technical support.

Failed Test - RED Bar

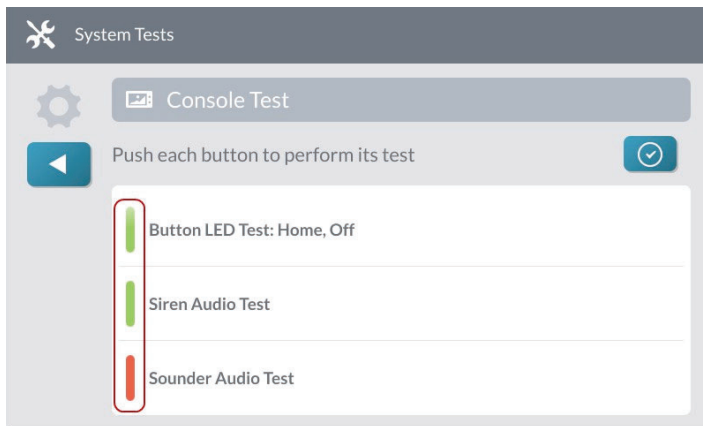

- Tap the  button.

## Firmware Update

For the GC3 Panel to work properly, special firmware is required. This firmware contains the background programming information that tells the GC3 Panel how to do things. As 2GIG makes improvements to the system, new firmware updates are released and can be installed as described here.

## Installing USB Firmware Updates

If your dealer provides you with a firmware update on a USB drive, you can connect that device to the USB port to update your system. This gives both the Master User and Installer the ability update the system's firmware as needed.

**NOTE:** To use this feature, you must know the four-digit Master User Code.

To install the firmware update:

- Insert a USB thumb drive storing the desired firmware version into the USB port at the top of the GC3 Panel.

GC3 Control Panel—Front View



- When the **Update** system icon and the **Firmware Update Available from USB Device** message appears, tap **Update**.

Firmware Update Available from USB Device

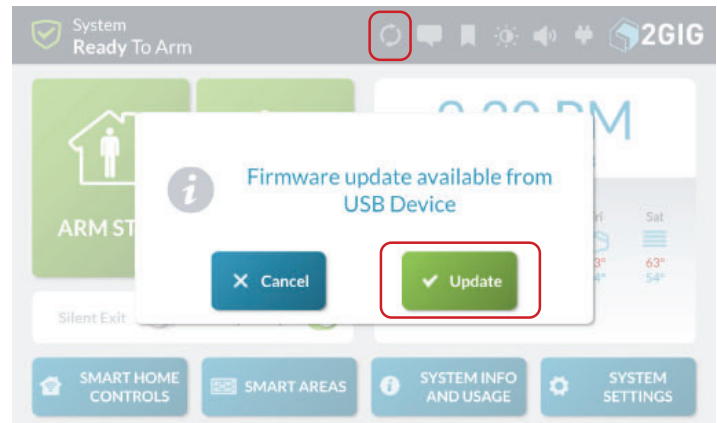

**NOTE:** If you do not tap Update in time, see “Installing USB Firmware Updates (System Icon)” below.

The GC3 Panel turns **BLACK** and in a few moments, the **Updating Firmware** message appears.

**IMPORTANT:** During the update process, do NOT disconnect the GC3 Panel from its power source and do NOT remove the USB thumb drive from the panel until the update is complete.

When the update is complete, the system restarts automatically and a new message appears in the system's Inbox to notify users that the firmware update was successful. See “Using the Inbox.”

**NOTE:** after updating, please wait 3 mins to allow GC3 to synchronize.

## Broadband

The built-in WiFi module and optional Ethernet module allow for broadband connection for dual-path communication, OTA updates, and connection with secondary keypads.

## Dual Path

Dual path communication is enabled by the backend provider if available and allows for 2-way communications between the panel and backend over broadband (WiFi or Ethernet) with the cell radio as a second path of communication.

**NOTE:** 2-way voice communication is available by cell radio only.

## OTA

“Over the Air” updates by broadband are supported for firmware v.3.1.0+, and High-Speed OTA is supported for firmware v.3.1.3+. Check with your backend provider about discounted pricing for OTA over broadband.

## Secondary Keypads

Broadband is also used for connection of secondary keypads (SP1 and SP2). Keypads can be connected to the same client WiFi as the main panel or to the systems internal Access Point. See the section “Access Point.”

## Installing USB Firmware Updates (System Icon)

To install an update:

1. Tap the **Update** system icon while the USB thumb drive is inserted.

*Update Firmware System Icon*

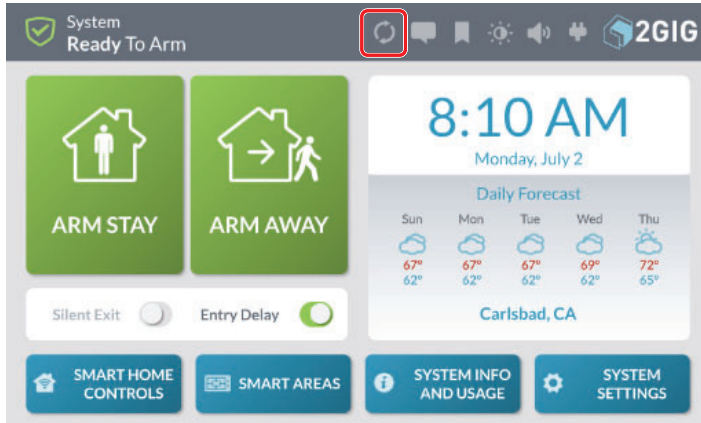

2. At the **Update Firmware** screen, tap **Update Firmware**.

*Update Firmware Screen*

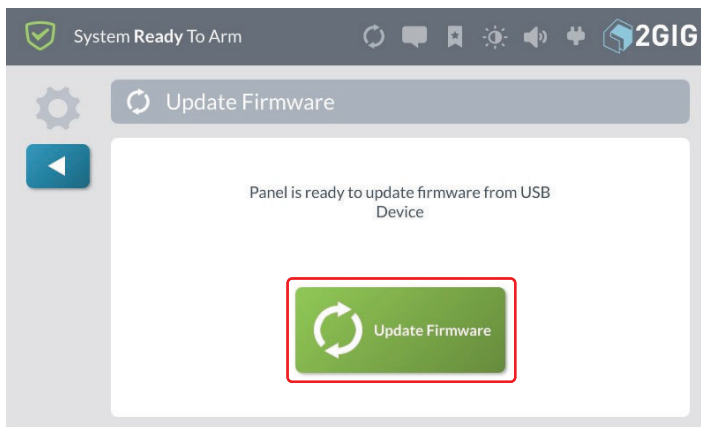

The GC3 Panel turns BLACK and in a few moments, the **Updating Firmware** message appears.

**IMPORTANT:** During the update process, do NOT disconnect the GC3 Panel from its power source and do NOT remove the USB thumb drive from the panel until the update is complete.

## Attaching to a Wireless Network

### Attach to a Wireless Network

1. Navigate to Installer Toolbox menu and tap **Network Settings**.

*Installer Toolbox*



2. Tap **Wireless**.

*Wireless Selection*

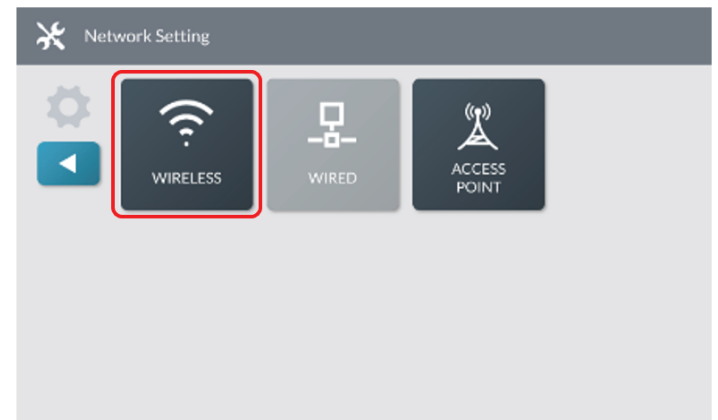

A list of available networks will be displayed.

3. Tap **Network** to connect to.

*Select Wireless Network*

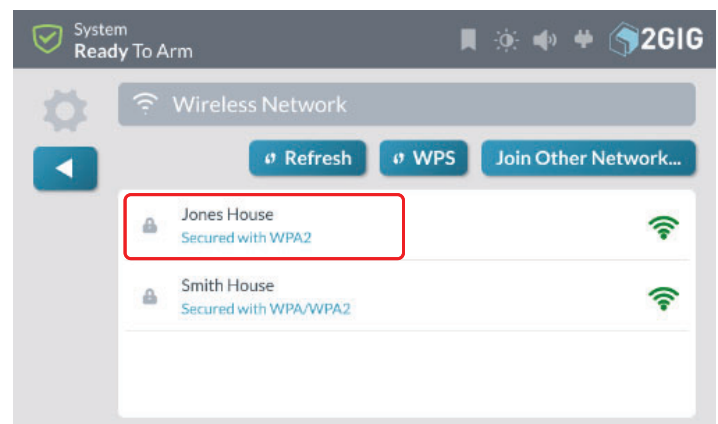



#### 4. Enter network password and tap **Next**.

*Keyboard Entry Screen*

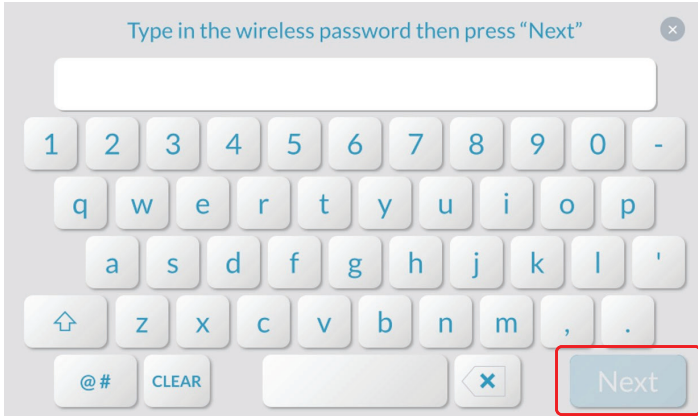

You will see the IP Address and other network information.

*Wireless Network Setup*

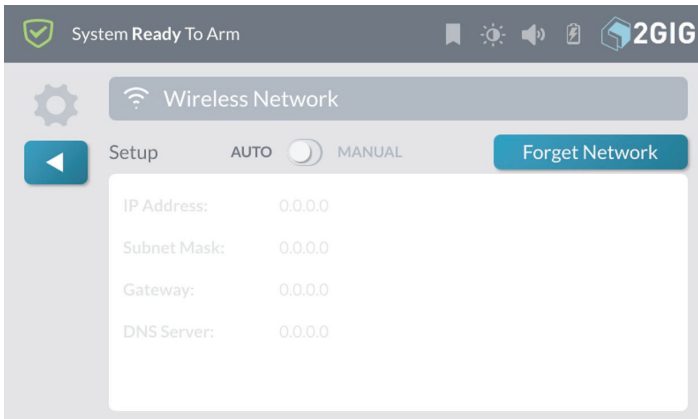

### Selection Buttons

#### Refresh

*Network Options*

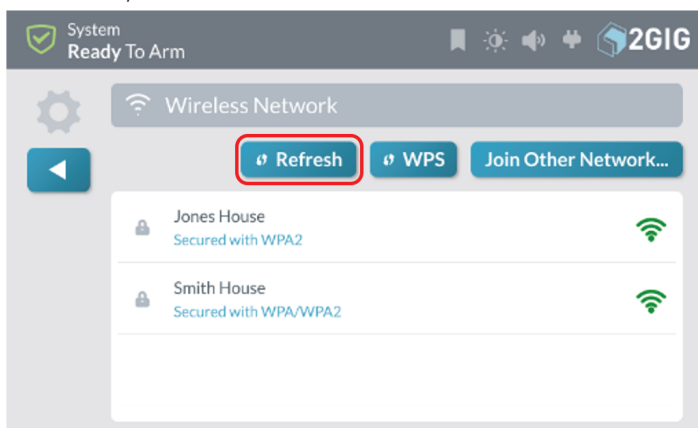

Tapping **Refresh** will refresh the list of available networks.

### WPS

Tapping **WPS** allows you to connect securely to routers that support WPS.

#### 1. Tap **WPS** on GC3 Panel.

*WPS Button*

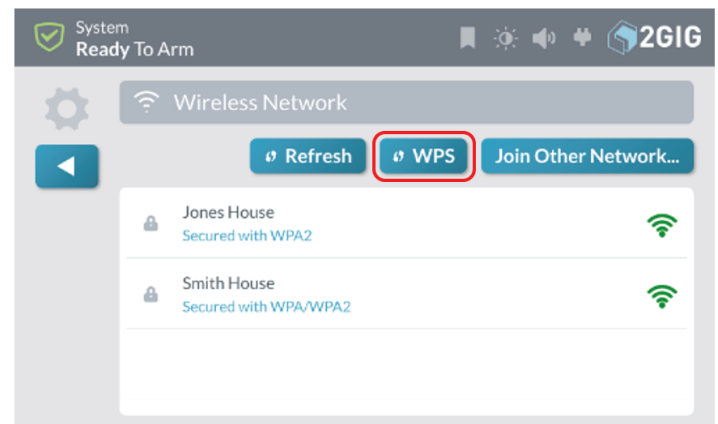

#### 2. Tap **Connect**.

*Connect Button*

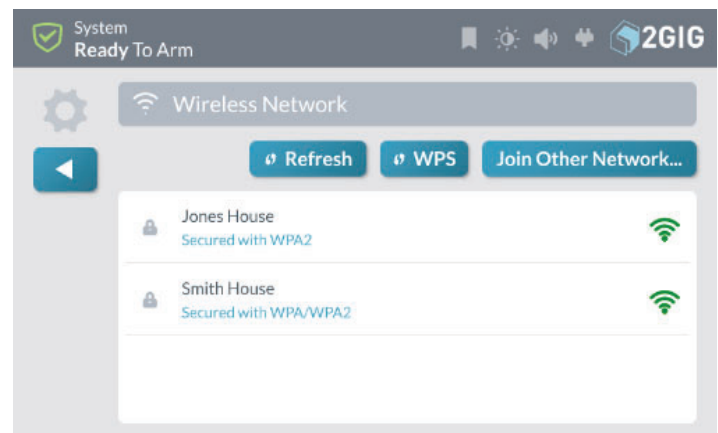

#### 3. Locate and press **WPS** on router.

GC3 Panel will securely connect with the router.

## Join Other Network

Tapping **Join Other Network** allows you to join a network not shown in the list.

1. Tap **Join Other Network**.

*Join Other Network*

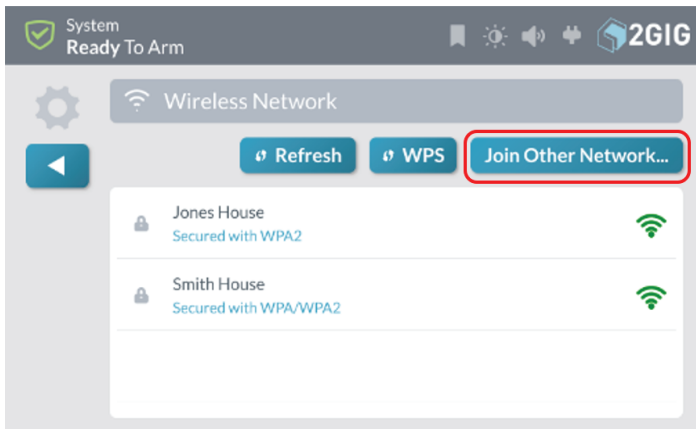

2. Enter network SSID.
3. Select authentication type used by the network.
4. Enter password.

## Forget Network

*Forget Network*

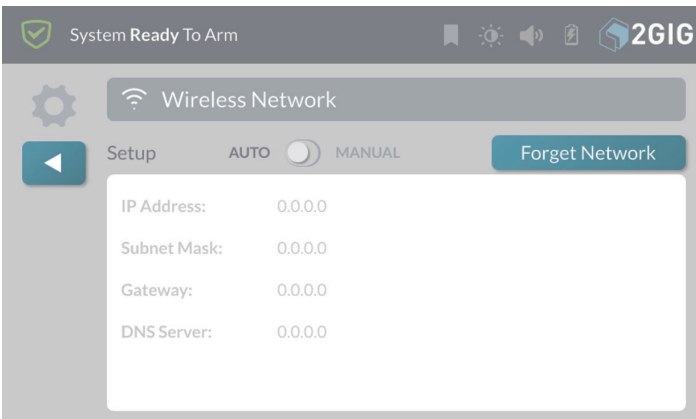

Tapping **Forget Network** disconnects the GC3 Panel from the wireless network and erases the password so that it will not automatically reconnect to the network.

## Wired (Ethernet)

### Attaching to a Wired Network (Ethernet Network)

Attach to a Wired Network.

1. Navigate to **Installer Toolbox** menu and tap **Network Settings**.



2. Tap **Wired**.

If the DHCP server is available on the network, the GC3 panel will automatically receive an IP address.

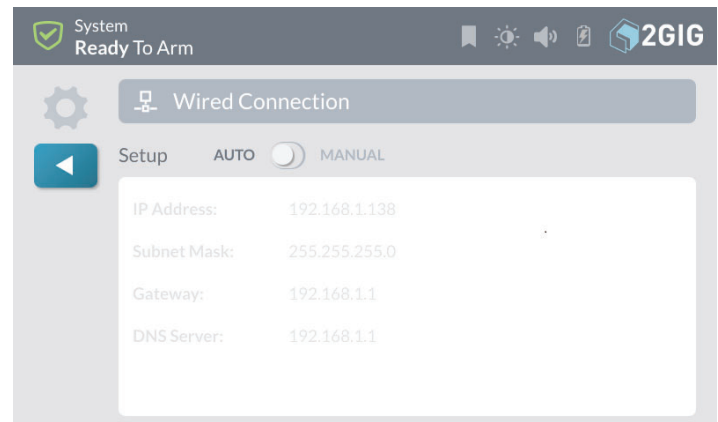

See the section “Setting up a Static IP address” to manually configure a static connection to the network.

3. Tap .

**NOTE:** Hardwired connection must be active for the Wired tile to be available. Once a hardwired connection is active the Wireless (WiFi) tile will be greyed out.

## Access Point

Setup the GC3 Panel Access Point

1. Navigate to the **Installer Toolbox** menu and tap **Network Settings**.
2. Tap **Access Point**

## Access Point

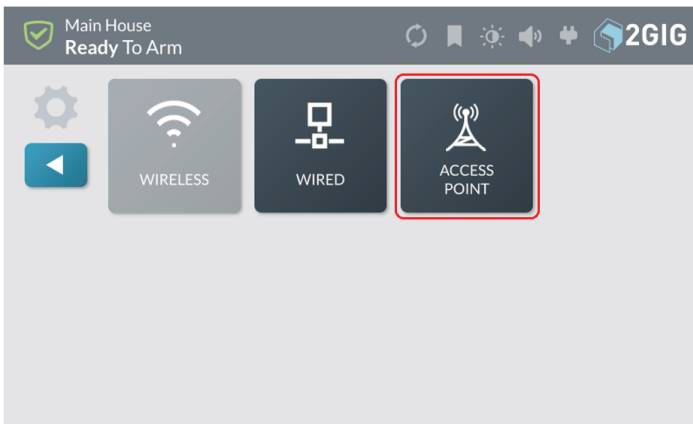

### 3. Enable Access Point

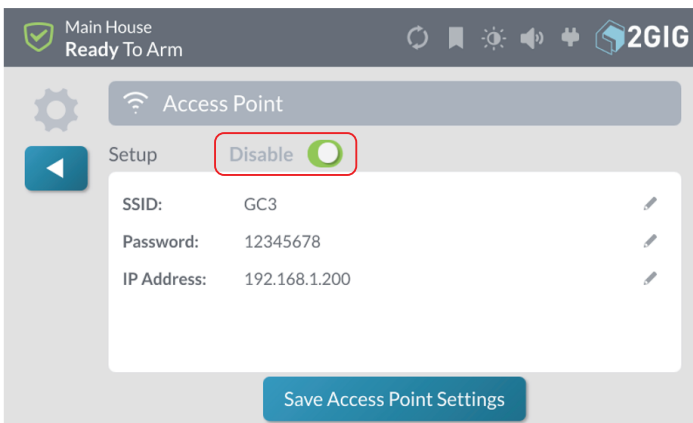

- » **Optional:** Press **Edit** icon next to default SSID, enter new SSID name
- » **Optional:** Press **Edit** icon next to **Password**, enter new password
- » **Optional:** Press **Edit** icon next to **IP address**, the last two octets of the Access Point can be changed to customize setup.

4. After any edits have been made, press **Save Access Point Settings** to save any configuration settings.

**Note:** Make a note of SSID and Password for use in WiFi setup of SP1 and SP2 keypads.

5. Tap .

## Setting Up a Static IP Address

By default the the GC3 Panel will connect using DHCP to get the IP Address assignment. If you want to set a Static IP Address, follow these steps.

1. Tap **Manual** and select the **Edit** icon for **IP Address**.

### Auto/Manual

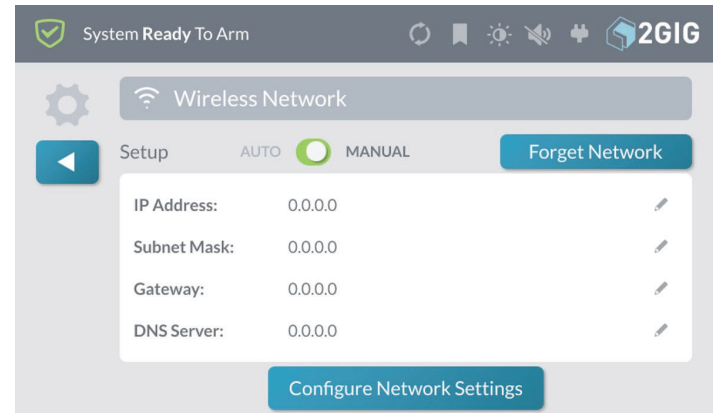

2. Enter the desired IP Address.

### IP Address



3. Select the edit icon for **SubNet Mask** and enter the desired **SubNet Mask Address**.

### Subnet Mask



- Select the **Edit** icon for **Gateway** and enter the desired **Gateway Address**.

Gateway Address



- Select the **Edit** icon for **DNS Server** and enter the desired **DNS Server Address**.
- Tap **Configure Network Settings**.

### Replace the GC3 Cellular Radio Module

After your system is installed, if your dealer supplies you with a new 2GIG cellular radio module, you can use the following instructions to install it into your GC2 Control Panel.

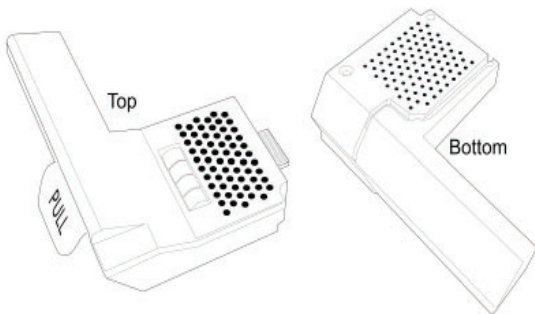

To replace the Cellular Radio Module into a system:

- From the **Home** screen, tap **System Settings**.

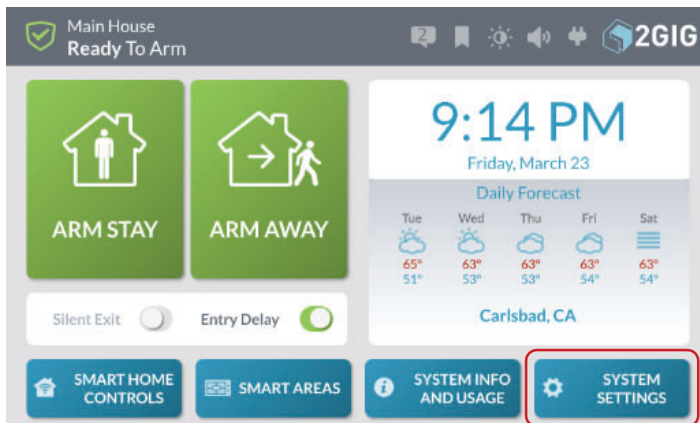

- From the **System Settings** menu, tap **Cell Radio Swap**.

### Cell Radio Swap

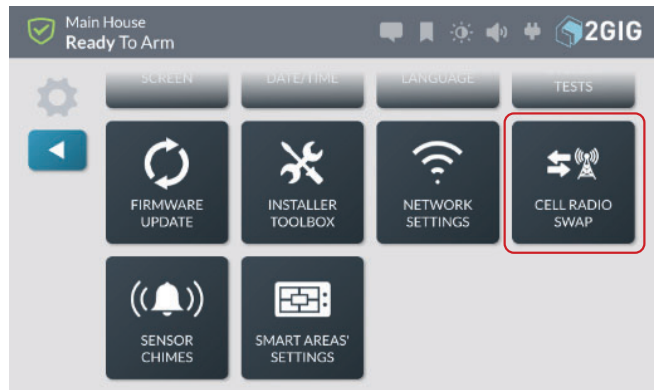

- Tap **Begin**.

Begin

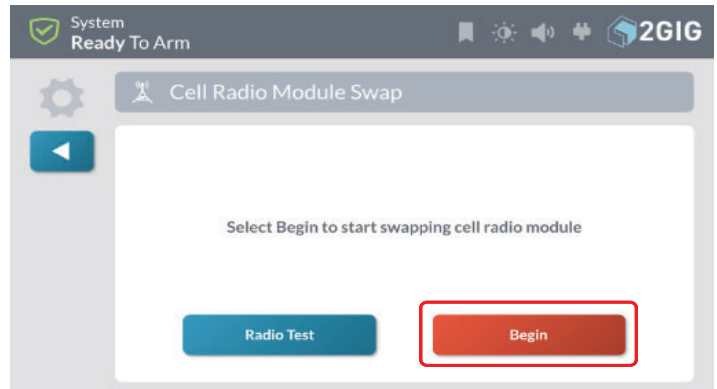

- Remove the hinged door from the GC3 Control Panel.

Remove Hinged Door

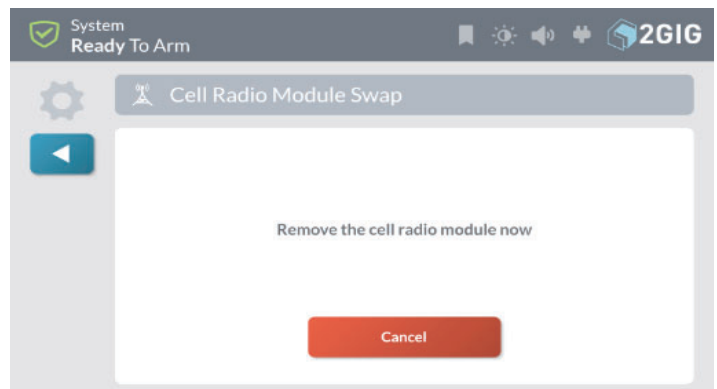

- Pull the tab to remove the Cellular Radio Module.
- Insert the Cellular Radio Module until it clicks into place and select **Done**.

### Select Done

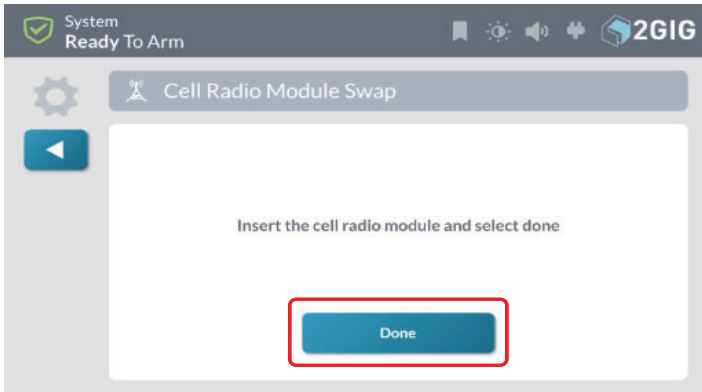

The following screen appears when the module is inserted and syncing with the system.

### Working

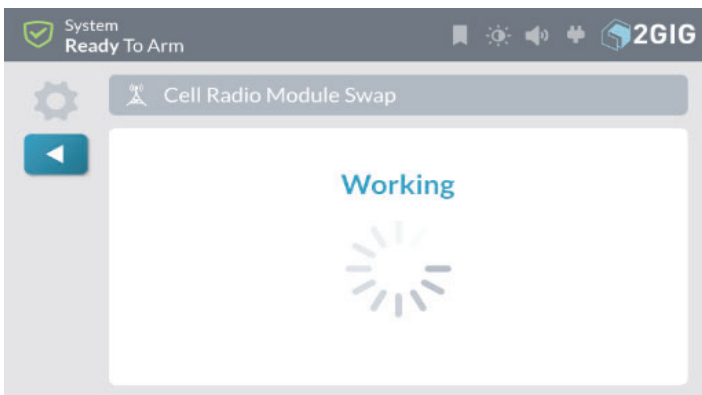

7. Press Radio Test.

### Radio Test

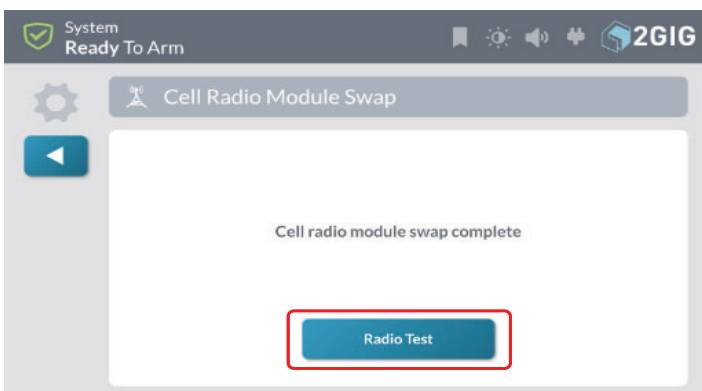

8. Press Start Radio Test.

### Start Radio Test

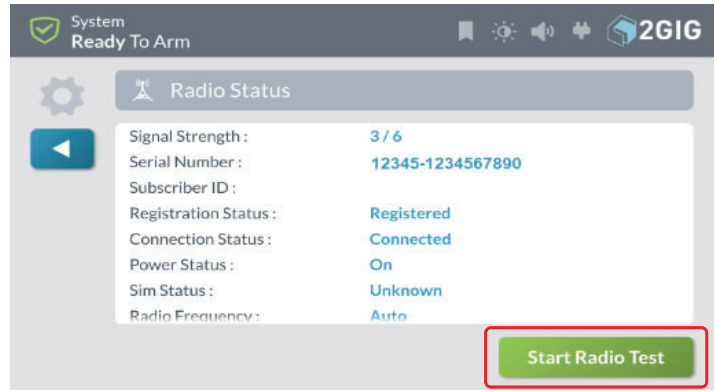

9. Confirm successful radio test.

### Confirm Test Successful

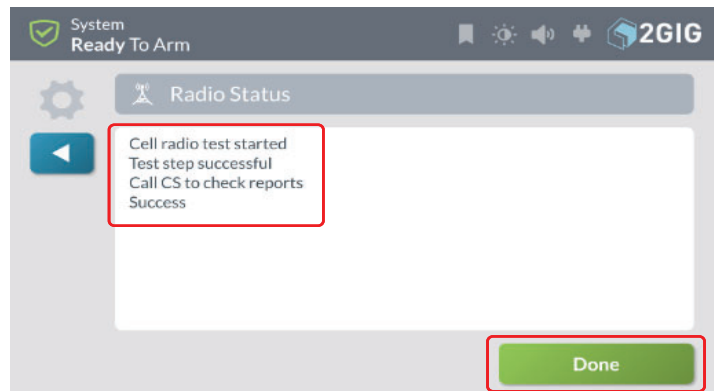

10. (Optional) Install the lock on the Cellular Radio Module bay door. See "(Optional) Lock/Unlock the Cellular Radio Module Door" in the section that follows.

11. Replace the hinged door.

12. Tap **Done**.

## (Optional) Lock/Unlock the Cellular Radio Module Door

The Cellular Radio Module fits into the bay on the side of the GC3 Panel and features a built-in door lock under the faceplate. The Control Panel ships with the door-lock screw in the UNLOCK position. To limit the possibility of someone removing the door, installers have the option of moving the screw to the LOCK position.

To lock and unlock the Cellular Radio Module door:

1. Use your fingertips or carefully insert a screwdriver at the edge of the faceplate. Then gently pry the faceplate from the chassis.

GC3 Panel—Removeable Faceplate

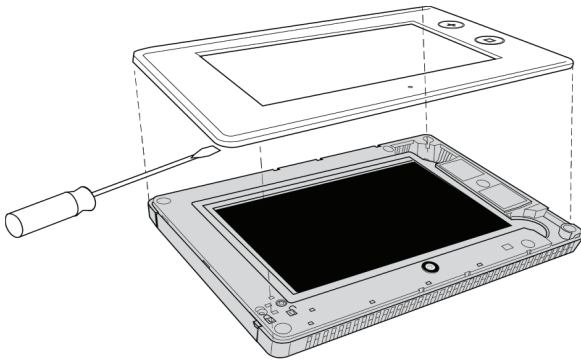

2. Remove the door-lock screw from the UNLOCK position on the right.

GC3 Panel—UNLOCK position

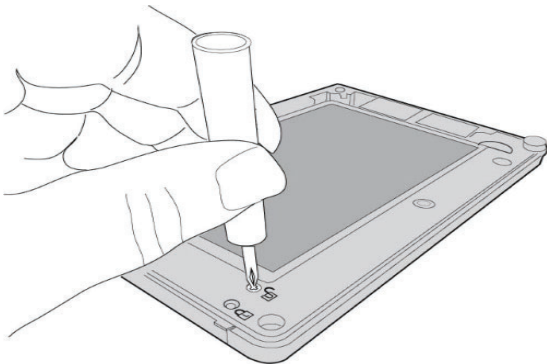

3. Install the screw into the LOCK position on the left. This locks the hinged door on the GC3 Control Panel.

GC3 Panel—LOCK position

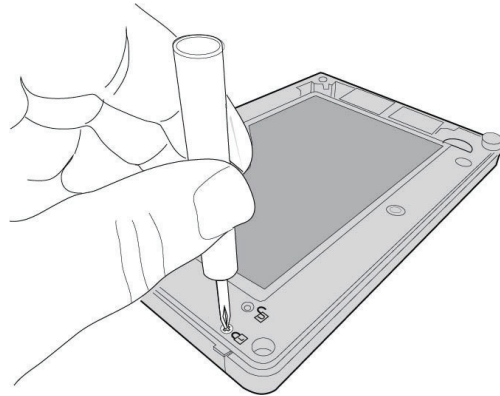

4. Snap the faceplate back on the GC3 Control Panel.

## Chimes

The master user can assign chimes to sensors to provide notification anytime a sensor is opened.

1. At the Home screen, tap **System Settings**.

Home Screen - System Settings

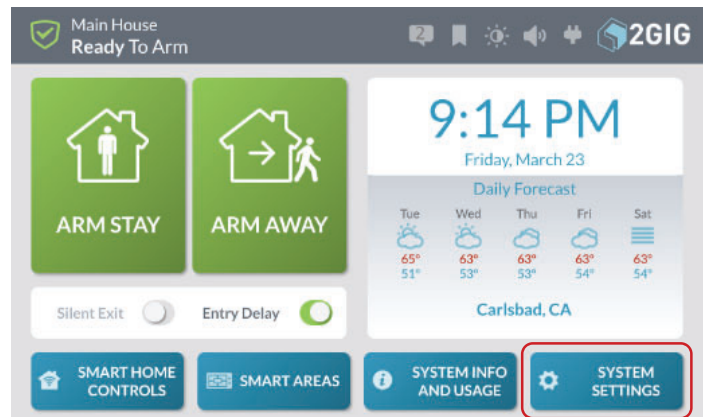

2. Select **Sensor Chimes**.

Sensor Chimes



3. Select a sensor from the list.

*Sensor List*

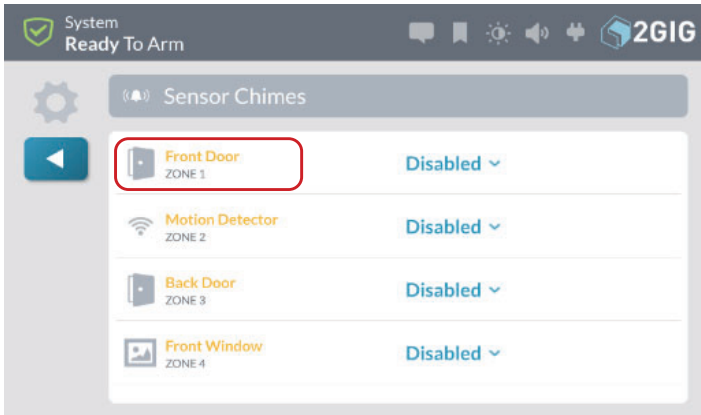

4. Select a chime from the dropdown list - an example will play when an option is selected.

*Select Chime*

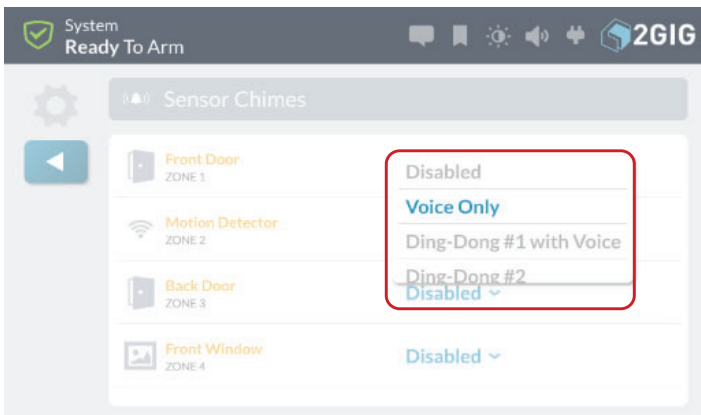

5. Select a chime for each sensor that requires a notification.

*Select Chime - Notification*

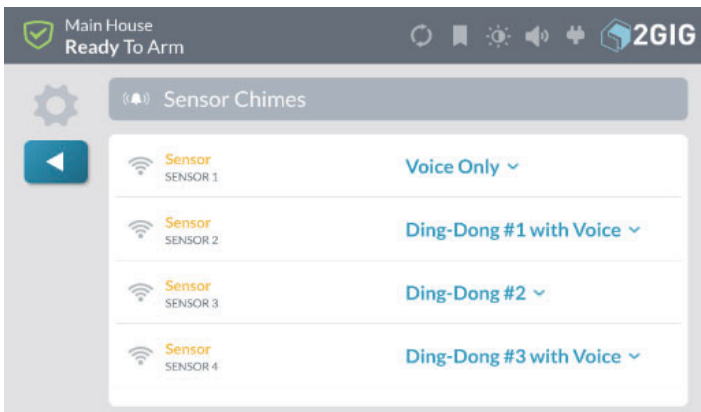

## Smart Areas Settings

The master user can edit the names of each Smart Area to display a unique name on the GC3 and SP1 user interface.

1. At the Home screen, tap **System Settings**.

*Home Screen - System Settings*

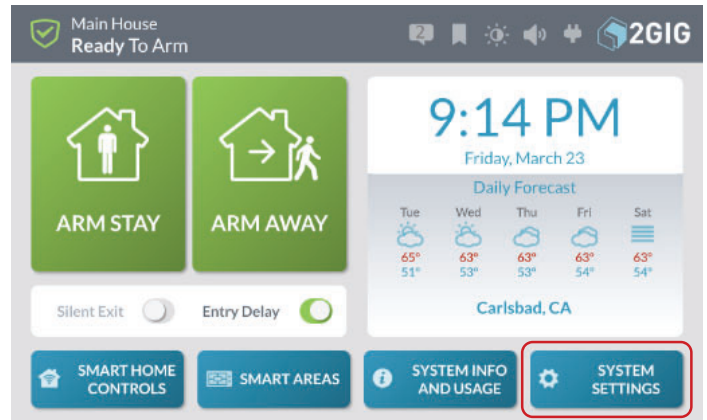

2. Select **Smart Areas' Settings**.

*Smart Areas*



3. Select the edit icon for the Smart Area to be edited.

*Edit Icon*

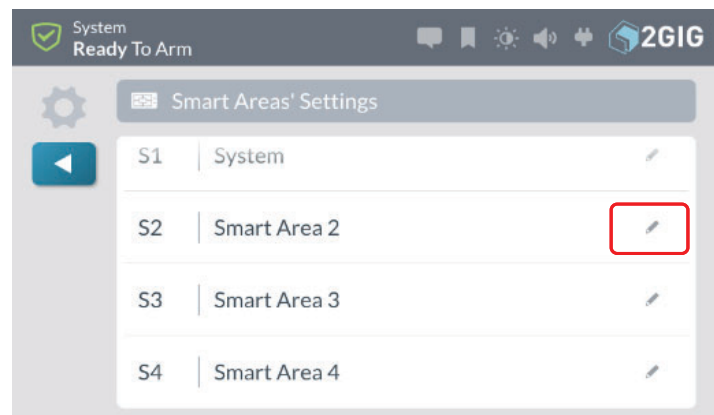

4. Use the keyboard to enter a unique name for the Smart Area.

*Smart Area Name*

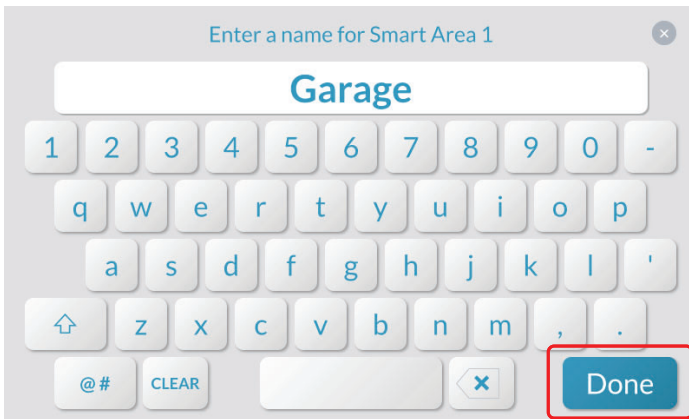

5. Press **Done**.
6. Repeat steps 3 & 4 to rename each Smart Area.

*Rename Smart Areas*

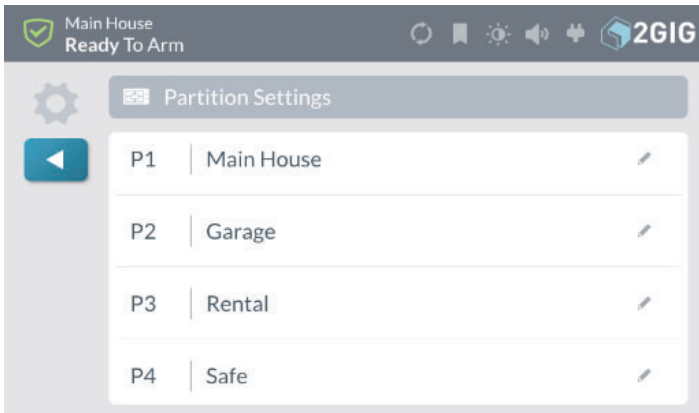



---

## Limited Warranty

This product is warranted against defects in material and workmanship for three (3) year. This warranty extends only to wholesale customers who buy directly from Nortek Security & Control LLC or through Nortek Security & Control's normal distribution channels. Nortek Security & Control LLC does not warrant this product to consumers. Consumers should inquire from their selling dealer as to the nature of the dealer's warranty, if any.

There are no obligations or liabilities on the part of Nortek Security & Control LLC for consequential damages arising out of or in connection with use or performance of this product or other indirect damages with respect to loss of property, revenue, or profit, or cost of removal, installation, or re-installation. All implied warranties for functionality are valid only until the warranty expires. This Nortek Security & Control LLC Warranty is in lieu of all other warranties, expressed or implied.

All products returned for warranty service require a Return Authorization Number (RA#). Contact Returns at 1-855-546-3351 for an RA# and other important details.

## Waste Electrical and Electronic Equipment (WEEE) Statement

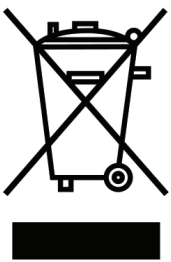

**This symbol on a product or on its packaging indicates that this product is not to be thrown away with everyday waste.**

Instead, it is your responsibility to dispose of electrical and electronics equipment by handing it over to a designated collection point for the recycling of waste electrical and electronic equipment (W.E.E.E.). The separate collection and recycling of your waste electrical and electronic equipment at the time of disposal will help to conserve natural resources and ensure that it is recycled in a manner that protects human health and the environment. For more information about where you can drop off your waste equipment for recycling, please contact your local city office, or your household waste disposal service, or the shop where you purchased the product.

## WARNINGS

### Limitations of Alarm Products

This product should be tested periodically to make sure it is working properly. The product, if used properly, may reduce the risk of burglary, robbery, and other adverse events that have the potential to result in injury or loss of life; however, Nortek Security & Control is not an insurer. This product is neither insurance nor a guarantee that such an event will be prevented, and users should protect themselves with proper insurance. Nortek Security & Control makes no representation that this product cannot be compromised or circumvented, that it will provide an adequate warning, or that it will prevent any personal injuries, property damage, or other losses. Like any alarm product, it may be bypassed, it is subject to compromise, and it may fail to warn for a variety of reasons, including, but not limited to: improper installation or positioning; improper maintenance; tampering; dead or improperly installed batteries; sensing limitations; component failures; receivers; intrusions may be outside of a product's designated range and certain environmental conditions may impact performance, and audible alarm signals may be outside of hearing range, muted by doors, walls, and floors, unheard by deep sleepers or the hearing-impaired, or overwhelmed by other sounds.

### Risk of Noise Induced Hearing Loss

The Alarm is equipped with a warning siren. Exposure to high sound levels or prolonged exposure to the warning siren can result in Noise Induced Hearing Loss (NIHL).

**ALARM DEALER INFORMATION**

**Company Name:**

**Your Account Number:**

**Installation Date:**

---

10004670 B